

GUIDELINEGEO | ABEM

ABEM Terrameter LS 2
User Guide





WARNING!

The ABEM Terrameter LS 2 delivers high voltages and currents. Always consider all cables and electrodes to carry current, whether connected directly or indirectly to the Terrameter.

Stay away from cables and electrodes while the system is operating. Wear electrically insulating boots and gloves during fieldwork. Disconnect cables from Terrameter / Electrode Selector before connecting and disconnecting electrodes to or from the cables.

To avoid accidents, the operator must always keep all parts of the equipment including instrument, electrode selector, electrode cables, electrodes etc. under close supervision and be aware of unauthorized persons and stray animals approaching while the system is operating.

Contents

THANK YOU FOR CHOOSING THE ABEM TERRAMETER LS 2	vi
ABOUT THIS MANUAL.....	vii
1 GET READY - UNPACKING YOUR NEW INSTRUMENT.....	1
1.1 Introduction	1
1.2 The Delivered Instrument.....	2
1.3 Inspection.....	3
1.4 Shipping Damage Claims	3
1.5 Shipping/Repacking Instructions	3
1.6 Registration	3
1.7 Compliance.....	3
2 OVERVIEW OF THE INSTRUMENT.....	4
2.1 The Connector Panel	4
2.2 The Power Panel.....	5
2.3 The Built-in GNSS Receiver	6
2.4 The User Interface Panel	6
2.5 The Power Supply.....	7
2.6 Operating in High Temperature Situations	9
2.7 Operating in a Thunderstorm	9
3 THE USER INTERFACE.....	10
3.1 The Display	10
3.2 The Keyboard	10
3.2.1 The Built-in Keyboard.....	11
3.2.2 The External Keyboard	12
3.3 VNC Control.....	12
3.3.1 Viewing / controlling the Terrameter LS 2 via VNC.....	12
3.4 Page, Tab and Menu Navigation	13
3.4.1 The Welcome Page	14

3.5	The Option Menus.....	16
3.6	Changing Texts and Values	16
3.6.1	Fixed Set of Values	16
3.6.2	The Keyboard Emulators	17
3.7	Data Management Conventions	19
3.7.1	Project.....	19
3.7.2	Task	21
3.7.3	Template	24
4	THE INSTRUMENT	27
4.1	Data Storage.....	27
4.2	Network Connections	28
4.2.1	LAN Client.....	29
4.2.2	LAN Server.....	29
4.2.3	Wi-Fi Access Point	29
4.3	GNSS (Global Navigation Satellite System) Receiver	30
4.4	Language	31
4.5	License.....	32
4.6	Calibration.....	33
4.7	The Relay Switch	33
4.7.1	The External Relay Switch(es)	34
4.8	Power Source	36
5	MEASUREMENT PREPARATION	37
5.1	Save Field Time With Good Preparation	37
5.2	Preparing for Data Acquisition	37
5.2.1	Create Projects and Tasks	37
5.2.2	Data Acquisition Settings	37
5.2.3	Create New Station	45
5.2.4	Cable and Electrode Exclusion	46
6	MEASUREMENT PROCEDURES	48
6.1	General.....	48
6.2	Essential Equipment	48
6.3	Recommended Additional Equipment.....	49
6.4	Setting up the Hardware	49

6.5	2D Electrical Imaging	50
6.5.1	General Cable Layout	50
6.5.2	Cable Joints	50
6.5.3	Take-out Overlap on 21 Take-out Cable Sets	51
6.5.4	Connecting Electrodes, Spread Cables and the Instrument.....	52
6.5.5	Roll-along and Specialist Station Types / Layouts	52
6.6	3D Imaging Via Several 2D Layouts (2.5D Survey)	54
6.7	3D Imaging by Electrode Grid Layouts	55
6.8	Marine Imaging Survey.....	56
6.9	Cross-Borehole Tomography	56
6.10	Performing Data Acquisition	57
6.10.1	Starting the Measurement.....	57
6.10.2	Electrode Contact Test	59
6.10.3	Progress Information	60
6.10.4	Data Viewing Options	61
6.10.5	Pausing and Stopping the Data Acquisition	63
6.10.6	Deleting, Undeleting and Re-measuring Data.....	64
6.11	Vertical Electrical Sounding	66
6.11.1	Managing Electrode Positions.....	67
6.11.2	Performing a VES Measurement.....	70
6.11.3	VES Sounding Curve	71
6.11.4	VES Table.....	72
6.12	Borehole Logging with the Terrameter Log 300	73
6.12.1	The Hardware.....	73
6.12.2	Quick Look: A Normal Borehole Logging Session.....	76
6.12.3	About Borehole Logging Measurement Modes	76
6.12.4	About Borehole Logging Measurement Types.....	77
6.12.5	Operating the Borehole Logging System.....	79
6.12.6	Working with Borehole Logging Data	85
6.13	Measurement Errors	86
6.14	Full Waveform Data.....	89
6.15	100% Duty Cycle IP Mode	90
7	POST-MEASUREMENT ACTIVITIES	91
7.1	Repacking the LS system.....	91
7.2	Export Measurement Data	91
7.2.1	Export a Task as a DAT File.....	91
7.2.2	Export a Task as a TXT (Text) File	92
7.2.3	Export a Task as a USF File	93
7.2.4	Export a Task as a LAS File.....	94
7.2.5	Export a Project.....	95

7.3	Delete a Project	96
8	TESTING, DIAGNOSTICS AND FAULT FINDING	97
8.1	Self Test	97
8.2	Cable Continuity Test	97
8.3	Cable Isolation Test	98
8.4	Cable Joint Tests	99
8.5	Remote Diagnostics	101
8.6	In Case of Malfunction	102
9	APPENDIX A. MEASUREMENT MODES	103
9.1	Self-Potential (SP)	103
9.2	Resistivity: “RES” Measurement Mode	103
9.3	Induced Polarisation (IP): “RES, IP” Measurement Mode	104
9.4	Induced Polarisation (IP): “RES, IP100” Measurement Mode	105
9.4.1	White Paper Extract: Time-efficient IP Measurements Using 100 % Duty Cycle	105
9.4.2	White Paper Extract: Increased Data Quality by Super-positioning the Signal.....	105
9.4.3	White Paper Extract: Exponential SP Background Removal for Increased Accuracy	106
9.4.4	White Paper Extract: Input Channel Filters Optimized for IP.....	107
9.4.5	White Paper Extract: Additional IP Parameters and Processing Available in Aarhus Workbench.....	107
9.4.6	White Paper Extract: Advantages of IP Using 100 % Duty Cycle.....	107
9.4.7	White Paper Extract: References	108
10	APPENDIX B. SURVEY PROCEDURE FOR COMMON CABLE SETS	109
10.1	Overview of 2-cable, 41 Electrode Layouts (2x21)	109
10.1.1	Setting-up for 2-cable, 41 Electrode Surveys	109
10.1.2	Create Project and Task for a 2-cable, 41 Electrode Surveys.....	109
10.1.3	Start Measurement on a 2-cable, 41 Electrode Survey	110
10.2	Overview of 4-cable, 81 Electrode Layouts (4x21)	111
10.2.1	Setting-up for 4-cable, 81 Electrode Surveys	111
10.2.2	Create Project and Task for a 4-cable, 81 Electrode Survey	111
10.2.3	Start Measurement on a 4-cable, 81 Electrode Survey	111
10.2.4	Measuring With Only Three 21 Take-out Cables	113
10.3	Overview of 2-cable, 48 and 64 Electrode Layouts (2x24, 2x32)	113
10.3.1	Setting-up for 2-cable, 48 or 64 Electrode Surveys.....	113
10.3.2	Create Project and Task for 2-cable, 48 or 64 Electrode Surveys	114
10.3.3	Start Measurement on 2-cable, 48 or 64 Electrode Surveys	114
10.4	Overview of 4-cable, 48 and 64 Electrode Layouts (2x24, 2x32)	115

10.4.1	Setting-up for 2-cable, 48 or 64 Electrode Surveys.....	115
10.4.2	Create Project and Task for 4-cable, 48 or 64 Electrode Surveys	115
10.4.3	Start a Measurement on 4-cable, 48 or 64 Electrode Surveys.....	115
11	APPENDIX C. SPREAD AND MEASURING SEQUENCE FILES.....	117
11.1	General.....	117
11.1.1	Typical Spread Files	117
11.1.2	Typical Measuring Sequence Files	118
11.1.3	Standard Test and Diagnostic Protocols	119
11.2	Spread Description Files in XML-format.....	119
11.2.1	Spread Files for Pole-dipole and Pole-Pole	120
11.3	Protocol Files in XML-format	121
11.3.1	Protocol Files for Pole-dipole	122
11.3.2	Protocol Files for Pole-pole.....	122
11.3.3	Optimising the Use of Channels for Pole-pole	123
11.4	Protocol Files in XML-format for VES.....	123
11.5	Legacy Formats.....	124
11.5.1	Cable Description Files in ADR-format	124
11.5.2	Protocol Files in ORG-format	124
11.5.3	Geometry Files	126
12	APPENDIX D. TERRAMETER LS TOOLBOX OVERVIEW	127
12.1	General.....	127
12.2	Connecting to the instrument.....	127
12.3	Working with a connected instrument	127
12.3.1	Disconnect.....	127
12.3.2	Manage Projects	128
12.3.3	Set timezone and time	128
12.3.4	Import/Export Spread and Protocol.....	128
12.3.5	Update	129
12.3.6	Enable TX Updating.....	129
12.4	Working with data.....	130
13	APPENDIX E. TECHNICAL SPECIFICATION	132
13.1	General.....	132
13.2	Receiver	133
13.3	Transmitter	133
13.4	Multi-Electrode Survey Systems for 2D & 3D	134
13.5	Software & Communication	134

GUIDELINEGEO

ABEM

THANK YOU FOR CHOOSING THE ABEM TERRAMETER LS 2

The ABEM Terrameter LS 2 is an innovative data acquisition system for self-potential (SP), resistivity and time-domain induced polarization (IP), incorporating the World's first commercial implementation of a 100% duty cycle mode for IP measurement*. The instrument has been carefully checked at all stages of production and is thoroughly tested before leaving the factory. It will provide many years of satisfactory service if handled and maintained according to the instructions given in this manual.

Guideline Geo will be pleased to receive occasional reports from you concerning the use and experience of the equipment. We also welcome your comments on the contents and usefulness of this manual. In all communication with ABEM be sure to include the instrument types and serial numbers. Contact details:

Address: Guideline Geo AB, Hemvärnsgatan 9, SE-171 54 Solna, Stockholm, Sweden.
Website: www.guidelinegeo.com
Phone number: +46 8 557 613 00
E-mail: sales@guidelinegeo.com
support@guidelinegeo.com

Note!	It is important that the person/organisation responsible for the instrument, notify Guideline Geo of their name and address. This allows us to provide updates with important information, upgrades of the built-in software and documentation. Please send your name and address directly to Guideline Geo, utilise the Warranty Registration Card delivered along with the instrument.
--------------	--

Under the copyright laws, this manual may not be copied, in whole or in part, without the written consent of Guideline Geo.

The product described in this document is subject to continuous developments and improvements. All particulars of the product and its use contained in this document are given by Guideline Geo in good faith. However, all warranties implied or expressed, including but not limited to implied warranties or merchantability, or fitness for purpose, are excluded. This document is intended only to assist the reader in the use of the product and every effort has been made to ensure that the information in this manual is accurate. Guideline Geo shall not be liable for any loss or damage arising from the use of any information in this document, or any error or omission in such information, or any incorrect use of the product.

Guideline Geo, the ABEM logo, are trademarks of Guideline Geo, registered in Sweden and other countries. Other company and product names mentioned herein are trademarks of their respective companies. Mention of third-party products is for informational purposes only and constitutes neither an endorsement nor a recommendation. Guideline Geo assumes no responsibility with regards to the performance or use of these third-party products.

* Only available on "Advanced" models

ABOUT THIS MANUAL

This manual is written for the end user of the product and explains how to set up and configure the product, as well as providing detailed instruction on its use. The conventions and formats of this manual are described below:

- Typographical conventions used in this manual:

<i>Italic</i>	Names of objects, e.g. screen / menu features, figure captions etc.
Bold	In-line minor headers, emphasis etc.
<i>Orange Italic</i>	URL links

- Formats used in this manual for highlighting special messages:

- Use of the internal keyboard is given in this format
 - A sequence of steps will have two or more of these parts
- Further information about a particular operation is given like this

Note! This format is used to highlight information of importance or special interest

Warning! Ignoring these types of notes might lead to loss of data or a malfunction



These notes warn of things that can lead to people or animals getting hurt or to equipment getting damaged

1 GET READY - UNPACKING YOUR NEW INSTRUMENT

1.1 Introduction

The ABEM Terrameter LS 2 is an innovative data acquisition system for self-potential (SP), resistivity (RES) and time-domain induced polarization (IP), incorporating the World’s first commercial implementation of a 100% duty cycle mode for IP measurement*. The instrument is delivered with everything that is needed for multi-electrode geoelectrical imaging along with your choice of imaging cables and electrodes.

The Terrameter LS 2 is fully compatible with existing ABEM electrical imaging components like electrode cables, cable joints, cable jumpers, electrodes, and electrode selectors (ES10-64C) for expansion. The built-in GPS automatically logs the instrument position during data acquisition, and ABEM Active Guidance provides assistance on every aspect of instrument operation and survey.

Figure 1 shows a complete system (except for the full number of electrodes and cable jumpers) plus the optional ES10-64C external switch box for increasing electrode numbers.



Figure 1 ABEM Terrameter LS 2 geoelectrical imaging system and accessories

* Available on “Advanced” models

1.2 The Delivered Instrument

Use great care when unpacking the instrument. Check the contents of the box or crate against the packing list. Figure 2 shows the parts that are shipped with a Terrameter LS 2 for basic imaging. Since March 2026, two Li-ion battery packs are also included in the box.



Figure 2 The Terrameter LS 2 instrument package

1.3 Inspection

Inspect the instrument and accessories for loose connections and inspect the instrument case for any damage that may have occurred due to rough handling during shipment.

The instrument is delivered in a rugged plastic flight case. The box is designed to offer a convenient and safe transport option. All packing materials should be carefully preserved for future re-shipment, should this become necessary. Always make sure to use the transport box provided, or an alternative of at least equivalent mechanical protection and shock absorption whenever the instrument is shipped.

1.4 Shipping Damage Claims

File any claim for shipping damage with the carrier immediately after discovery of the damage and before the equipment is put into use. Forward a full report to ABEM, making certain to include the ABEM delivery number, instrument type(s) and serial number(s).

1.5 Shipping/Repacking Instructions

The ABEM packing kit is specially designed for the Terrameter LS 2. The packing kit should be used whenever shipping is necessary. If original packing materials are unavailable, pack the instrument in a wooden or shatter-proof plastic box that is large enough to allow some 80 mm of shock absorbing material to be placed all around the instrument. This includes top, bottom and all sides. Never use shredded fibres, paper or wood wool, as these materials tend to pack down and permit the instrument to move inside its packing box. **To return instruments to ABEM, please find our shipping instructions on our website.** For further assistance please contact ABEM or its authorised distributor. Contact information can be found in the beginning of this document.

1.6 Registration

When you have checked the packing list, the next important thing to do is to register your Terrameter LS 2. To register send an email with your contact information to support@guidelinegeo.com. Once registered, you will be able to receive notifications of software updates and product information.

1.7 Compliance

The Terrameter LS 2 and the accessories are in conformity with the essential requirements in the Low Voltage Directive 73/23/EEG, 93/68/EEG and the Electromagnetic Compatibility Directive 89/336/EEG with amendments 92/31/EEG and 93/68/EEG of the EC.

2 OVERVIEW OF THE INSTRUMENT

2.1 The Connector Panel

All connectors except external power are situated on the right-hand side panel of the Terrameter LS 2 (Figure 3).



Figure 3 The connector panel of the Terrameter LS 2

LABEL	FUNCTION
Ethernet	Connection for RJ45 Ethernet cable for network communication
USB	Connection for USB memory sticks, keyboard, mouse etc.
SD/SIM	Connection for microSD memory card and micro-SIM card
Connector 1	32-pole connector for electrode cables (1/2)
Connector 2	32-pole connector for electrode cables (2/2) (not on VES edition)
C1, C2	Banana plug connection for current electrodes (for VES, connection of remote electrodes or tests)
P1, P2	Banana plug connection for channel 1 potential electrodes (for VES, connection of remote electrodes or tests)
AUX	Connection of external devices, such as the Terrameter SAS LOG 300 or ES10-64C
Ground	For earthing the unit to a ground spike / spare electrode

2.2 The Power Panel

The power panel of the Terrameter LS 2 is shown in Figure 4.



Figure 4 The power panel of Terrameter LS 2

The Safety Switch Button has two possible positions. The inner position corresponds to the safety switch condition while the outer position corresponds to the operating condition.

Current can only be transmitted if the Safety Switch Button is in the outer position. If the Safety Switch Button is pressed during measurement current transmission will stop immediately without closing down the measurement session. The measurement can be resumed again as soon as the button is released. The Safety Switch Button is released to the outer position by twisting it clockwise.



Before releasing the Safety Switch Button, the operator must have full control of the instrument and the entire electrode cable layout, so that people and animals do not get close to the electrodes and electrode take-outs connected to the measurement cables!

Note! The power panel can get hot when operating, especially when transmitting with high power. Be careful when handling a Terrameter in order to avoid burning anything. See also Chapter 2.5 *The Power Supply*.

2.3 The Built-in GNSS Receiver

The Terrameter LS 2 has a built-in GPS and GLONASS receiver that automatically saves positioning data along with all measurements. To function well, the built-in antenna (in the handle of the instrument, Figure 5) must be able to receive signals from a sufficient number of satellites. This will not normally be possible indoors and severely limited in outdoor areas with a limited view of the sky, for example in a forest. Lying the instrument on its back during data collection also limits the antenna's effectiveness. An external GNSS can be used to provide positioning via the USB port on the end-panel of the instrument (see Chapter 4.3 GNSS (Global Navigation Satellite System) Receiver)



Figure 5 The GNSS (GPS) antenna is integrated in the left side of the handle

2.4 The User Interface Panel

All interaction with the Terrameter LS 2 is done through the user interface panel (Figure 6). This comprises the built-in keyboard, full colour display, and LED window.

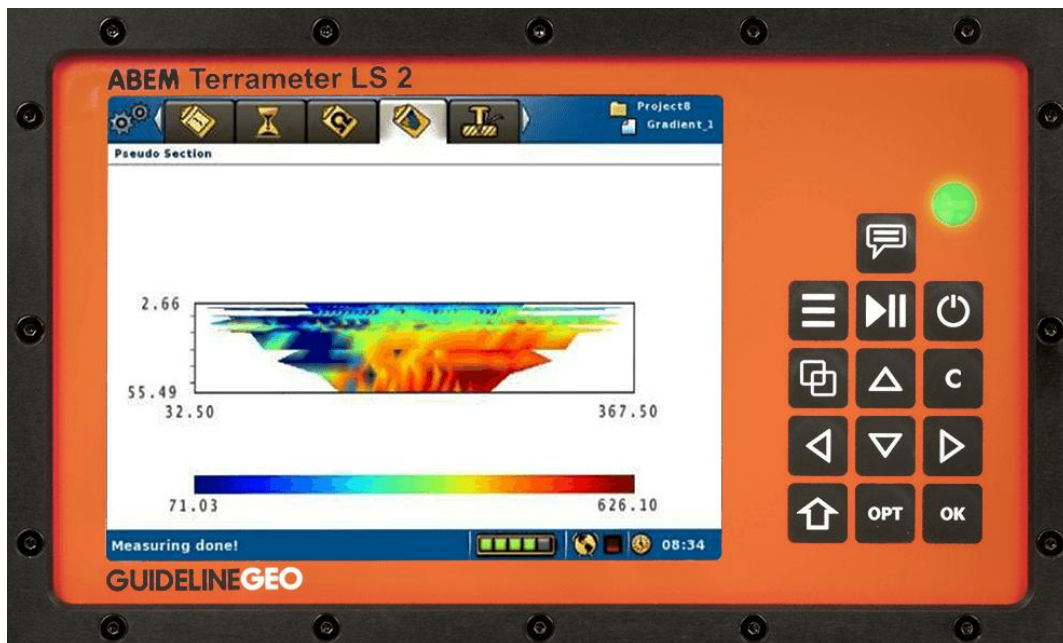

Figure 6 The user interface panel

There are two LED's shown through the *LED Window*:

- The green LED is a heartbeat indicator meaning that the software is alive.
- The red LED indicates read/write activity.
- The orange LED is related to various power states during normal operation.

2.5 The Power Supply

During stand-by, the Terrameter draws very little current; however, depending on the circumstances, it can draw large currents during transmission, sometimes up to 30A. The external battery and its cable must be designed accordingly. For fieldwork, use a good, adequate capacity, recently-charged battery and the supplied cable set, if possible.

The internal battery / batteries are primarily designed as a backup power source for operating the instrument during set-up, moving between stations, data transfer etc. but may also be used for limited low-power surveys, for example VES measurements on reduced power. The internal battery / batteries are charged by connecting the Office Power Supply to the *External Power Supply connector*. The charger will automatically stop charging when the battery / batteries are full. It is possible to remove the internal battery / batteries, and it can sometimes be required for transportation by airplane. If the protective liner that keeps the cells together (previous NiMH battery) or the casing (current Li-ion batteries) is found to be damaged during inspection, please contact Guideline Geo support for further information. It is possible to fully run the Terrameter LS 2 without the internal battery / batteries but for your convenience you should always charge the battery / batteries before starting measurement activities.

Note! All batteries self-discharge over time. If discharged too much it will decrease the battery capacity. It is recommended to charge the internal and external batteries immediately after survey and at least once every three months, if not in use.

Once the instrument has been turned on, if the external battery is disconnected for any reason, it will automatically switch to the internal battery / batteries. This function even works during the initial start-up process. This useful feature makes it possible to disconnect the external battery temporarily without shutting the instrument off when moving, for instance, from one measurement station to another.















The battery-switching function will, in any situation, give priority to the external battery if it is connected and the voltage is more than 9 V. More information about the internal and external voltage levels can be found in Chapter 4.8 *Power Source*.

The table overleaf provides a guide to the battery indicator. The values are not exact but give an indication of voltage levels from the battery sources at that moment. The battery indicators are the leftmost of the *Notification Icons* on the *Status Bar* (Figure 7).

The ABEM Office Power Supply (21-33310032) is not suitable for measurements – it is designed purely for working on the instrument whilst indoors. It is neither weatherproof nor power-rated for survey conditions. The ABEM Power Adapter (10-006021) is an optional accessory that allows the Terrameter to be run from a small mobile generator. This rugged AC-DC converter is able to cope with fast-changing and, often, high-current demands of the Terrameter during measurement, whilst still providing a stable 12V supply.



The Office Power Supply should never be used for undertaking field measurements.

External battery indication	Approximate battery voltage or status	Internal battery indication	Approx. percentage of full charge or status
	Over 12.2 V		81 - 100 %
	11.6 – 12.2 V		61 - 80 %
	11.4 – 11.6 V		41 - 60 %
	10.9 – 11.4 V		21 - 40 %
	Under 10.9		Under 20 %
	External battery not connected		Internal battery not connected
	Office power supply connected		Internal battery charging

The current dual Li-ion internal battery solution allows for hot-swapping. This means that, provided one of the batteries is fully inserted into its slot, the Terrameter will remain powered-on whilst the second battery is removed / replaced.

If an external power source is not detected, The Terrameter switches to the internal battery / batteries. However, the following start-up scenario should be looked out for as an indication that all available power sources are depleted:

1. If the external battery has a voltage that is *just* over the 'OK' limit the instrument will proceed to the stage where the more power-draining display lights up.
2. The voltage on the already weak battery will now drop below an acceptable level.
3. The instrument then goes into a resting (standby) state.
4. The external battery will now recover to a higher voltage level.
5. The instrument records sufficient voltage to reattempt the start-up sequence.
6. The display lights up, with a following drop in voltage, and a forced resting state.

This sequence can continue repeatedly for a long time. In case this happens, the immediate action is to disconnect the battery and have it replaced or charged. Always use a good quality, newly charged, battery for your survey.

After a measurement is started, the power supply voltage is allowed to temporarily drop to 9V when the transmitter is active. Therefore, the instrument may temporarily indicate a low battery voltage while transmitting high current into the ground.

2.6 Operating in High Temperature Situations

Every individual Terrameter LS 2 is operated for at least one hour in a heat chamber during the delivery test. During normal operating condition a thermal fuse will turn off the instrument if overheating occurs. This is to prevent damage and it will of course halt the measuring process.

Some precautions to avoid overheating:

- Protect the instrument from direct sunlight. Keep it in the shade, consider use of a parasol or similar if needed.
- Do not operate the instrument in small, closed spaces, for example within transport boxes, where air cannot circulate freely. The power panel (left side of instrument) must have good ventilation around it.

2.7 Operating in a Thunderstorm

If a thunderstorm should come up while out in the field with the instrument, then remember to first stop any ongoing measurement process and then disconnect the cables from the terminals without touching any bare conductors. Never leave the cables connected to the Terrameter LS 2 overnight unless they are equipped with adequate lightning protection since a thunderstorm may occur.



**Never take
measurements during
a thunderstorm!**

3 THE USER INTERFACE

The user interacts with the instrument through the User Interface Panel. This Chapter explains the basics of this interaction.

3.1 The Display

All information shown on the display is referred to as the *Screen*. Figure 7 shows the layout of the *Screen*.

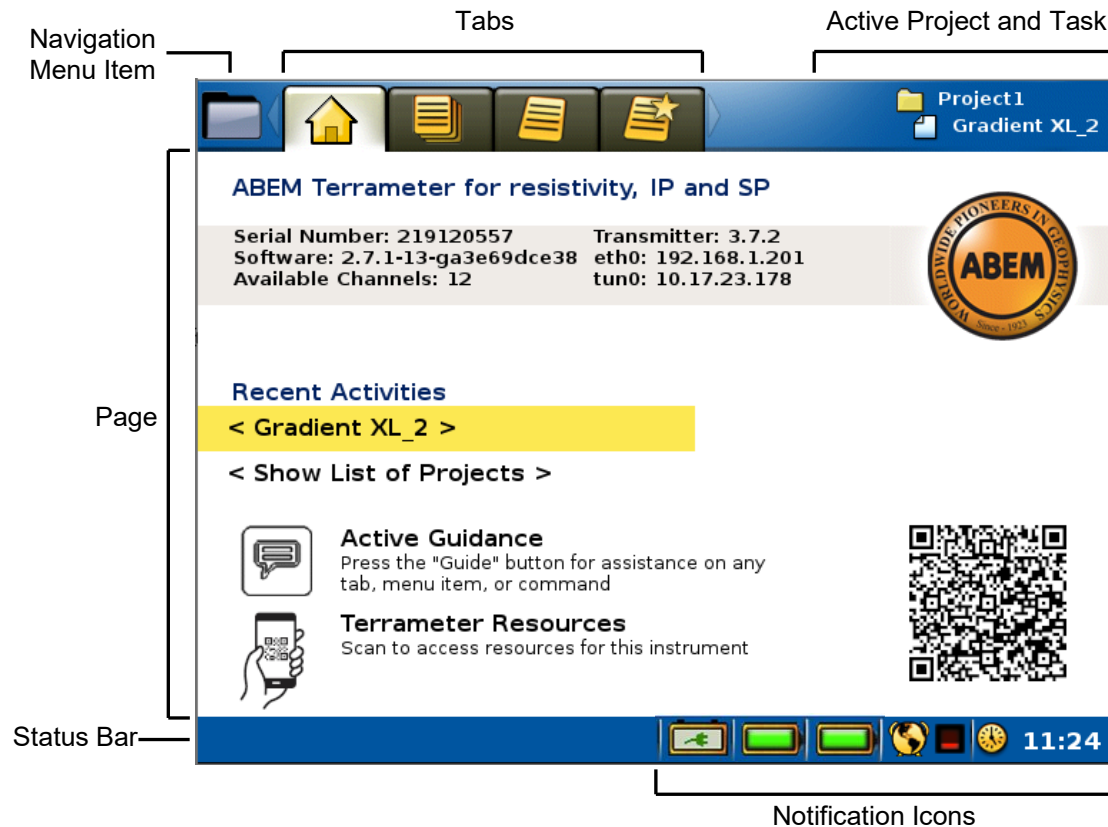

Figure 7 The screen layout – note that older instruments using a single NiMH battery only show one internal battery icon in the Notification area

The *Screen* layout components:













- Navigation Menu Item and Tabs are described in Chapter 3.4 *Page, Tab and Menu Navigation*.
- Page shows different information depending on where the user has navigated.
- Active Project and Task shows the currently opened Project and Task.
- Status Bar shows interactive messages in the left part and notifications in the right part (see below).
- Notification *Icons* show Battery status, GPS status and time of day.

3.2 The Keyboard

Commands from the user are entered through a keyboard. There is a built-in keyboard on the front-panel but an external keyboard can also be used via the USB port on the end-panel.

3.2.1 The Built-in Keyboard

The table lists the names of the buttons as referenced in this document.













	<ABEM Active Guidance>		
	<Menu>		<Left>
	<Play-Pause>		<Right>
	<Power>		<Down>
	<Browse>		<Shift>
	<Up>		<Options>
	<Clear>		<OK>

The corresponding function of the buttons are summarized below:

- <ABEM Active Guidance>** Detects the currently active command, screen, or menu item and provides relevant guidance on it.
- <Menu>** Show the Navigation menu
- <Play-Pause>** Jump to the *"Measure/Progress"* Page / Start or pause measuring
- <Power>** Turn instrument on or off
- <Browse>** Jump between the *Tabs* of a navigation *Menu Item*
- <Up>** Move Cursor / Highlight up
- <Clear>** Close dialog
- <Left>** Move Cursor / Highlight left
- <Down>** Move Cursor / Highlight down
- <Right>** Move Cursor / Highlight right
- <Shift>** Change function of other buttons
- <Options>** Show the option menu for the highlighted object
- <OK>** Select / Show the keyboard emulator

3.2.2 The External Keyboard

A standard USB computer keyboard can be connected to the Terrameter LS 2 and used instead of the built-in keyboard. The mapping between the built-in buttons and the computer keyboard is listed in this table:

	<F9>		<Arrow Left>
	<Alt>		<Arrow Down>
	<F10>		<Arrow Right>
	<F12>		<Shift>
	<Tab>		<F11>
	<Arrow Up>		<Enter>
	<Esc>		

3.3 VNC Control

A standard VNC server is installed on the Terrameter LS 2 which means that screen mirroring and remote control of the instrument is very simple. Devices on any platform (PC, Apple, iOS, Android, Linux etc. as VNC protocols are universal) can be signed into the instrument allowing screen mirroring and remote control. A widely used, cross-platform software is VNC Viewer which, at the time of writing, can be downloaded from the RealVNC website (<https://www.realvnc.com/en/connect/download/viewer>). Users/observers can be local to the Terrameter or fully remote and still watch or operate the system.

3.3.1 Viewing / controlling the Terrameter LS 2 via VNC

Install a VNC viewer on the chosen viewing / control device and connect the device to the LS directly via Wi-Fi or Ethernet cable (for accessing a remote instrument via the internet, please contact support@guidelinegeo.com). Start the chosen VNC software, there will be some option for creating a new connection; enter the IP address shown on the Terrameter "Welcome" or "Network" tab (depending upon the software used, it may be necessary to append the value "::5900" directly after the IP address).

The VNC server on the instrument is password protected. Enter "Guideline" (case sensitive) when prompted; it may be useful to save the password, if that option is given. The software is likely to give a warning message due to the connection being unencrypted, accept this and the LS 2 desktop should appear on your device. Use the external keyboard controls shown in the previous section of this manual to control the instrument.

3.4 Page, Tab and Menu Navigation

The active view on the instrument (called a *Page*, see Chapter 3.1 *The Display*) will be one of a number of pages, grouped together by function, shown as *Tabs* at the top of the *Screen*. These pages are arranged in a two-level menu tree (Figure 8), accessed via the <Menu> button (see Chapter 3.2 *The Keyboard*). The top level has four *Menu Items*, each with several *Sub-items*.

When referring to a specific page, the format “*Menu Item/Sub-item*” will be used for instance “*Instrument/Network*” to describe the network information *Page*.

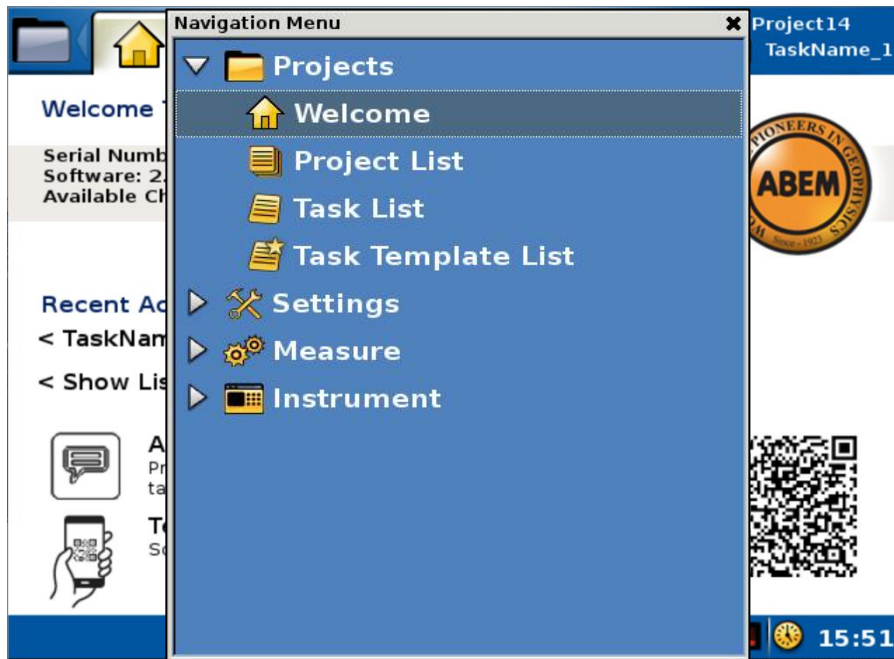

Figure 8 The Navigation Menu over the “Projects/Welcome” Page

The details of the *Navigation Menu* are marked in Figure 9.

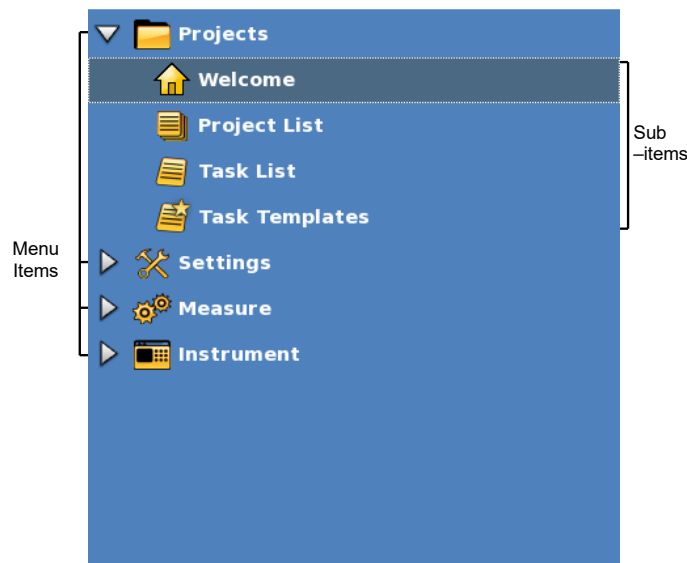

Figure 9 Navigation menu: “Welcome” Sub-item selected from the “Projects” Menu Item

The four *Menu Items* are:

Projects	3.7 <i>Data Management Conventions</i>
Settings	5.2.2 <i>Data Acquisition Settings</i>
Measure	6.10 <i>Performing Data Acquisition</i>
Instrument	4 <i>The Instrument</i>

Each *Sub-item* corresponds to a specific *Tab* on the *Screen* (again, Chapter 3.1 *The Display* explains these concepts). Each *Tab* represents a specific *Page* of information. It is a one-to-one match between the three concepts.

- **Sub-Item:** part of the *Navigation Menu*, matches a specific *Tab / Page* on the *Screen*.
- **Tab:** part of the *Screen* layout, acts as a navigation aid for the user.
- **Page:** part of the *Screen* layout, showing the requested information.

There are three different ways to change the current *Page*:

- Stepping from one *Page* to another on the *Screen*
 - Press <Browse> to step forward (i.e. move one *Tab* to the right)
 - Press <Shift> + <Browse> to step backward (i.e. move one *Tab* to the left)
- Jump directly to the “*Measure/Progress*” *Page*
 - Press <Play-Pause>
- Using the *Navigation Menu*
 - Press <Menu> to bring up the *Navigation Menu*
 - Press <Up> and/or <Down> to step up and down in the *Navigation Menu*
 - Press <Right> to open a closed *Menu Item* and show its *Sub-items*
 - Press <OK> to show the *Page* associated with the currently selected *Sub-item*

If a *Menu Item* instead of a *Sub-item* is highlighted when <OK> is pressed, then the latest used *Page* of that *Menu Item* will be opened

Note! The only way to change the available *Pages* from one *Menu Item* to any of the other *Menu Items* is via the *Navigation Menu*

3.4.1 The Welcome Page

When starting the Terrameter LS 2 the “*Projects/Welcome*” *Page* (Figure 10) will appear. Here the serial number of the instrument, the application software version, the number of measurement channels, the transmitter firmware version, the network IP address and the VPN tunnel address (if applicable) are displayed. Furthermore, the name of the most recent

measurement activity is displayed in the top-right of the *Screen*, and a QR code linking directly to resources associated with the Terrameter is shown at the bottom-right of the *Page*.



Figure 10 The Welcome Page

In the middle of the page there are two rows with shortcuts to other *Pages*.

- Using the shortcuts
 - Press <Up> or <Down> to highlight one of the two rows
 - Press <OK> to change to the *Page*

For the first of these rows there are two possible situations:

- If the active *Project* does not have any *Task*:
The text “< Task is missing. Please create >” will be shown.
Pressing <OK> in this case will change *Page* to the “*Project/Task List*” *Page* for the currently active *Project*. This *Page* is explained in Chapter 3.7.2 *Task*.
- Otherwise, if the active *Project* does have a *Task*:
The name of the active *Task* will be shown. See Figure 10 for an example. Pressing <OK> will, in this case, change to the “*Measure/Progress*” *Page* of this *Task*. This *Page* is explained in Chapter 6.10.1 *Starting the Measurement*.

Pressing <OK> on the second row, will have the same result as a single press on the <Browse> button; the *Page* will change to the “*Project/Project List*” *Page*. Chapter 3.7.1 *Project* has an explanation of this *Page*.

Note! A step-by-step summary of how to undertake ERT and VES measurements is provided in the Active Guidance screen associated with the Welcome Page. This provides a useful guide / reminder to the key steps to take.

3.5 The Option Menu

Figure 11 shows an example of an *Option Menu*; these can be found on five *Pages*:

- “*Projects/Project List*”
- “*Projects/Task List*”
- “*Projects/Task Templates*”
- “*Measure/Progress*”
- “*Measure/Electrodes*”
- “*Measure/Electrode Positions*”

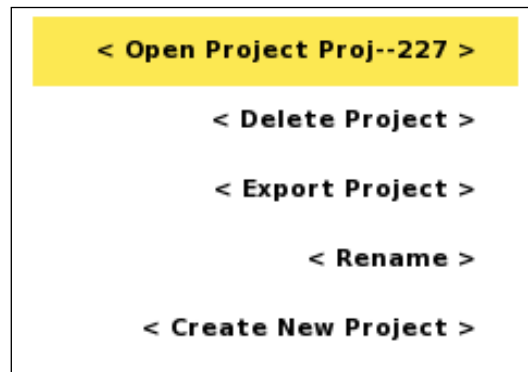

Figure 11 Option menu example

- Opening and using an *Option Menu*

- Pressing <Options> will generally show a pop-up *Option Menu*
- Press <Up> or <Down> to highlight one of the menu items
- Note that some menu items might be disabled and cannot be highlighted
- Press <OK> to perform the action highlighted on the *Option Menu*

The content of the *Option Menu* will differ depending on what is highlighted when the <Options> button is pressed. It functions in a similar way to the right-click context menu on a desktop PC.

3.6 Changing Texts and Values

There are three main ways to change values:

- Choose from a fixed set of values (see 3.6.1 *Fixed Set of Values*)
- Edit text (for instance names) using a keyboard emulator (see 3.6.2 *The Keyboard Emulators*)
- Edit numerical values using a keypad emulator (see 3.6.2 *The Keyboard Emulators*)

3.6.1 Fixed Set of Values

A left and right pointed arrowhead will surround the value when there is a fixed set of values to choose from (Figure 12).

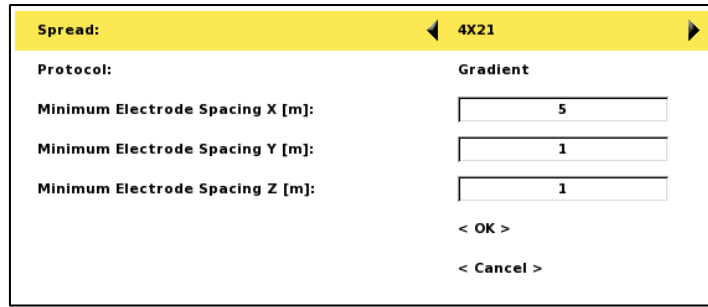

Figure 12 Example of a fixed choice value

- Changing a fixed choice value

– Press <Left> and/or <Right>

3.6.2 The Keyboard Emulators

Two different keyboard emulators are available when using the built-in keyboard to enter text and data values. One emulator is alphanumeric and the other is numeric. Alternatively, an external USB keyboard can be used.



Figure 13 Alphanumerical keyboard emulator

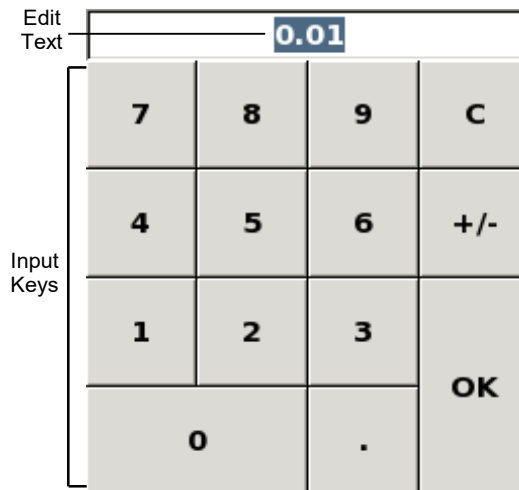

Figure 14 Numerical keypad emulator with component parts labelled

The editable text will be highlighted when a keyboard emulator is opened.

- Opening a keyboard emulator

- Make sure the text to be edited is highlighted or has the blinking cursor inside
- Press <OK>

If the editable text is numeric, a numerical keypad emulator (Figure 14) is shown, otherwise an alphanumeric keyboard emulator appears (Figure 13)

- Navigating the emulators

- Press the arrow buttons (<Left> <Right> <Up> <Down>) to either move the cursor within the editable text or to select an input key

- Deleting from the editable text in the alphanumeric keyboard emulator

- Press <Left> or <Right> to move the cursor to the right of text to be deleted
- Press <Down> to move the cursor from the editable text to the input keys
- Press <Right> until the “<-” input key is selected; this input key works as a backspace button on a traditional PC keyboard
- Press <OK> once for every character to be deleted

- Resetting the edit text to “0” in the numerical keypad emulator

- Press <Down> to move the cursor from the edit text to the input keys
- Press <Right> until the “C” input key is selected
- Press <OK> and the number is replaced with a “0”

- Changing the editable text

- Press <Left> and/or <Right> to move the cursor to the correct place within the editable text
- Press <Down> to move the cursor from the editable text to the input keys
- Navigate to the wanted input key
- Press <OK>

- Substituting the editable text when that text is highlighted

- Press <Down> to move the cursor from the editable text to the input keys
- Navigate to the wanted input key
- Press <OK> and the number or character will replace the highlighted text

- Saving the text

- Navigate to the input key at the bottom-right (“Done!” or “OK”)
- Press <OK>

- Cancelling without saving

Note! This is only possible when the keyboard emulator has been opened from a dialog where there is a Cancel button. An example of this is the *Project Name* dialog (Figure 19)

- Navigate to the input key at the bottom-right (“Done!” or “OK”)
- Press <OK>
- Highlight the “Cancel” button and press <OK>

3.7 Data Management Conventions

It is helpful to define a set of conventions which can be used to classify, store and manage measurement data in a comprehensible way. The Terrameter LS 2 uses the following categories in the user software: *Project*, *Task* and *Template*. This Chapter will explain these naming conventions as well as explain how to use them on the actual instrument.

3.7.1 Project

A *Project* is a container for measurement *Tasks*. A set of *Tasks* in a single *Project* could group measurements from the same site, or the same day, or the same contract.

Projects are managed in the “*Projects/Project List*” Page (Figure 15 Project List Page). Here *Projects* can be created, deleted, renamed or exported.

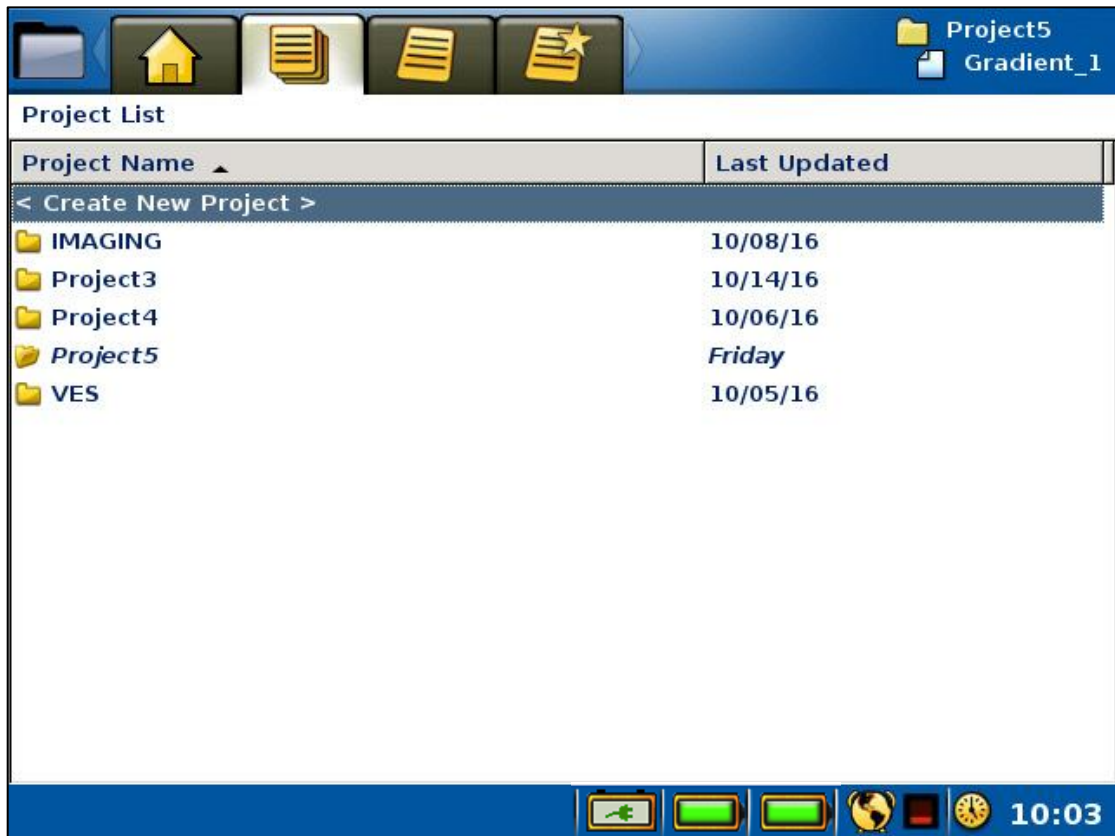

Figure 15 Project List Page

- Create a new *Project*

- Move the highlight to the top-most row (“<Create New Project>”)
- Press <OK>

Alternatively, the “<Create New Project>” item of the *Project* option menu can be used to create a new *Project*, see below.

- Opening the *Project* option menu

- Move the highlight to the required *Project*
- Press <Options> and the option menu (Figure 16) will be shown

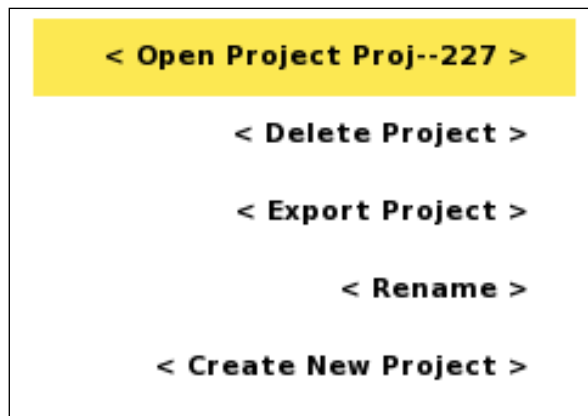

Figure 16 *Project* Option menu with *Open* item highlighted

The *Menu Items* of the *Project* option menu comprise:

Open	The <i>Project</i> is made active and the “ <i>Projects/Task List</i> ” for the <i>Project</i> is shown; same as pressing <OK> on a highlighted <i>Project</i>
Delete	A confirmation dialog is shown (Figure 17) and the <i>Project</i> will be deleted if the user confirms the deletion
Export	See Chapter 7.2.5 <i>Export a Project</i>
Rename	See below
Create New Project	Creates a new <i>Project</i>

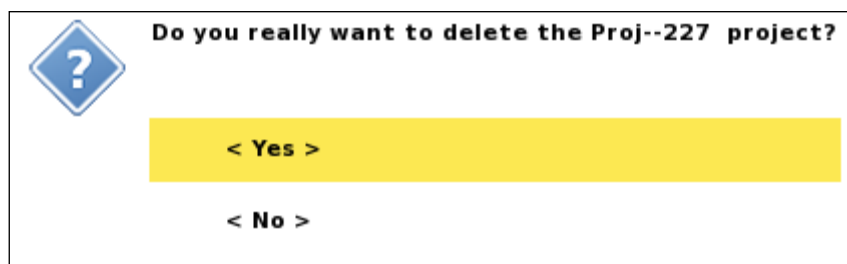

Figure 17 *Confirm Project Delete* dialog

- Renaming a *Project*
By default, new *Projects* are all named “Project” with sequential numbering.

- Open the *Project* option menu
- Move the highlight to <Rename> (Figure 18)
- Press <OK> and the Rename form will be shown (Figure 19)



Figure 18 Project option menu with the Rename item highlighted

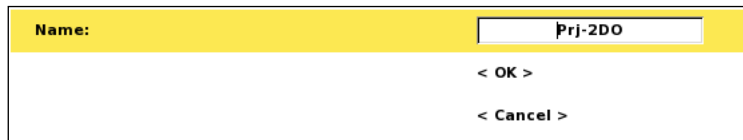

Figure 19 Rename dialog

3.7.2 Task

A *Task* is a dataset collected by running a measurement protocol. *Tasks* can be a 2D/3D imaging layout (including roll-along steps), a VES sounding, a borehole measurement, or laboratory measurements. *Tasks* are managed in the “*Projects/Task List*” Page (Figure 20 Task List Page) where they can be created, deleted, renamed, exported and more.

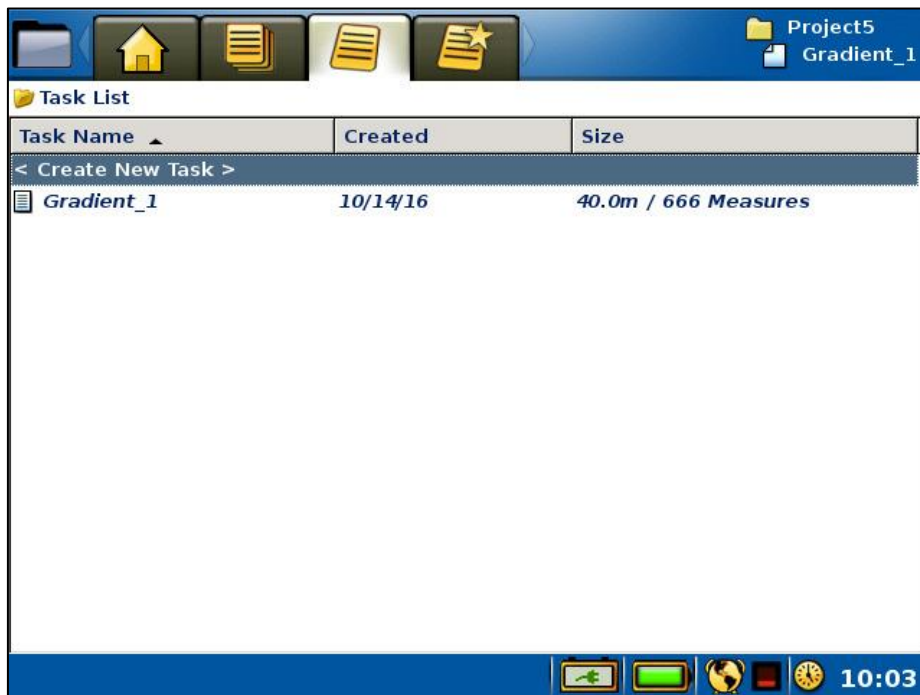

Figure 20 Task List Page

- Create a new *Task*

When creating a new *Task* the type of electrode spread must be defined. The spread describes to the instrument the relative layout of electrodes, for instance a 2D layout with 4x21 cables or a 2D layout with 2x24 cables. Furthermore, a protocol file is selected which defines all the electrode combinations required to complete the task. Finally, the electrode take-out spacings need to be entered.

- Move the highlight to the top-most row (“<Create New Task>”)
 - Press <OK> and the Create New *Task* dialog will be shown (Figure 21)
 - Press <Left> and/or <Right> to pick the electrode spread
<ABEM Active Guidance> provides details about the most common spreads
 - Press <Down> to highlight Protocol
 - Press <Left> and/or <Right> to pick the protocol file
<ABEM Active Guidance> provides pros/cons for common protocols
- If the default values of electrode spacing need to be changed then:
- Press <Down> to highlight *Electrode Spacing X* and/or *Y*; only spacing directions used in the selected spread are active. VES spreads do not require a spacing value; they have absolute electrode positions embedded within them.
 - Press <OK> and the numerical keyboard emulator will be shown
 - Enter the required electrode spacing and return, see Chapter 3.6.2 *The Keyboard Emulators*
 - Press <Down> to highlight the OK button
 - Press <OK>

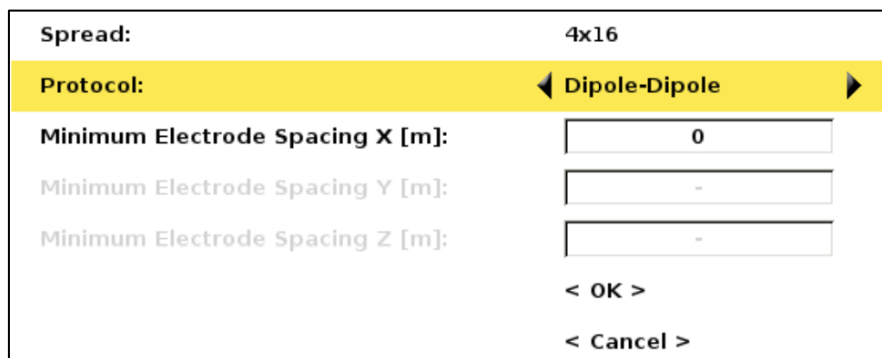

Figure 21 Create new task dialog

Alternatively, the “<Create New Task>” item of the *Task* option menu can be used to create a new *Task*, see below.

Note! After creating a new *Task* it is often necessary to check, and possibly modify, the data acquisition settings before starting to collect any measurements. For this reason, the screen will automatically switch to the “*Settings/Receiver*” Page for a newly created *Task*, see Chapter 5.2.2 *Data Acquisition Settings*

- Opening the *Task* option menu

- Move the highlight to the desired *Task*
- Press <Options> and the option menu of Figure 22 will be shown



Figure 22 Task option menu with the Create New Task item highlighted

The *Menu Items* of the *Task* option menu:

Open	The <i>Task</i> is made active and the “Settings/Receiver” Page is shown
Rename	See below
Save As Template	See Chapter 3.7.3 <i>Template</i>
Delete	<i>Task</i> will be deleted if confirmed by user in pop-up (Figure 23)
Export	See Chapter 7.2 <i>Export Measurement Data</i>
New from	A new <i>Task</i> will be created with the highlighted <i>Task</i> as a template. This works the same as opening from an ordinary <i>Template</i> but does so directly from the selected task, see Chapter 3.7.3 <i>Template</i>
Create New Task	Creates a new <i>Task</i>

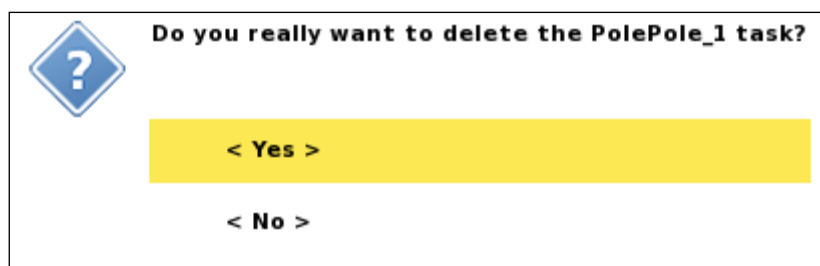

Figure 23 Confirm Task Delete dialog

- Renaming a *Task*.
By default, a new *Task* will automatically be named after the chosen protocol; for instance, using a Gradient protocol will give the name “Gradient_X”, where X is an automatically incremented number. This name can be edited.

- Open the *Task* option menu
- Move the highlight to <Rename> (Figure 24)
- Press <OK> and the Rename form will be shown. This is similar to the rename form of the *Project* (Figure 19); keep the cursor in the name box and press <OK> to bring up the keyboard emulator (Chapter 3.6.2 *The Keyboard Emulators*)

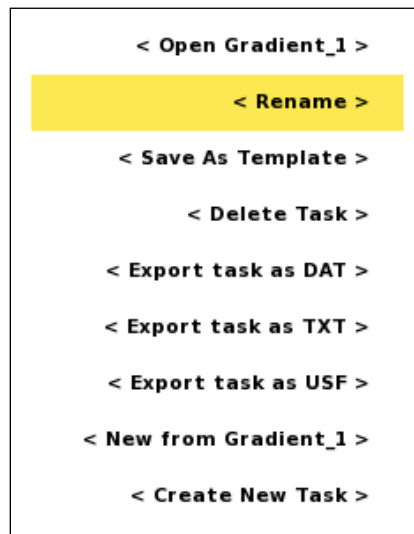

Figure 24 Task Option menu with the Rename item highlighted

3.7.3 Template

A complete measuring setup used for a particular *Task* can be saved as a *Template*. This makes it easy to create a new *Task* with the same data acquisition settings as used previously. This helps to avoid overlooking the change of any setting away from the default, or last used, to a value suited to the intended measurement.

Note! There is no acquisition data stored in a *Template*, just *Task* settings.

A *Template* can only be created from the “*Projects/Task List*” Page using the *Task* option menu (Figure 25).

- Create a *Template*, i.e. save the settings from a *Task* as a *Template*

- Open the “*Projects/Task List*” Page
- Move the highlight to the wanted *Task*
- Press <Options> and the *Task* option menu will be shown
- Move the highlight the <Save as template> item (Figure 25)
- Press <OK>

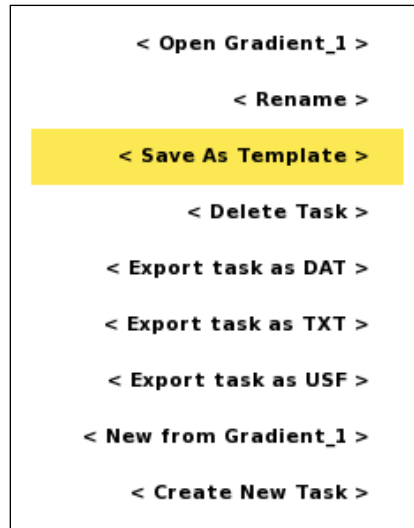

Figure 25 Task Option menu with the Save As Template item highlighted

Templates are managed in the “Projects/Task Templates” Page (Figure 26), and have an option menu associated with them for administration (Figure 27).

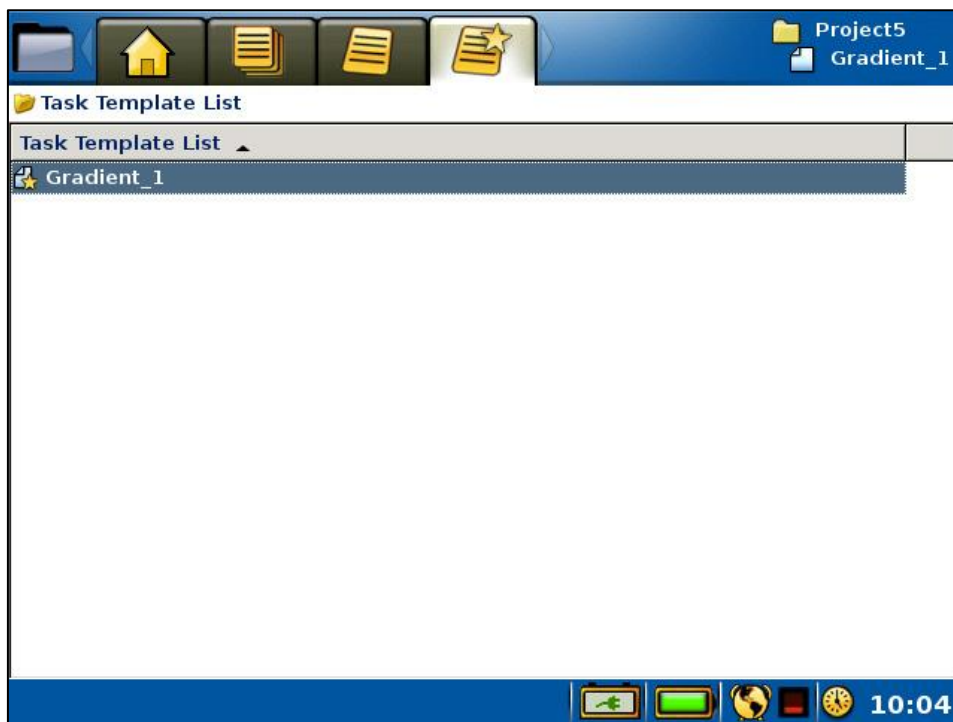

Figure 26 Task Templates Page

- Opening the *Template* option menu
 - Move the highlight to the wanted Template
 - Press <Options> and the option menu of Figure 27 will be shown



Figure 27 Template Option menu with the “New from” item highlighted

The Menu Items of the *Template* option menu:

New from	Creates a new <i>Task</i> from this <i>Template</i> , see Chapter 3.7.2 <i>Task</i> for more information about the procedure for creating <i>Tasks</i> .
Rename	See below
Delete	A confirmation dialog is shown (Figure 28) and the <i>Template</i> will be deleted if the user confirms the action

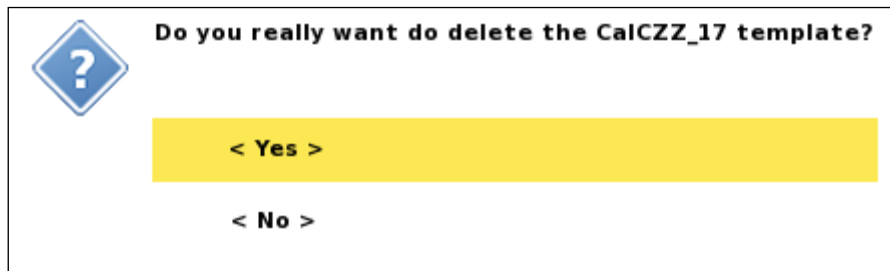

Figure 28 Confirm Template Delete dialog

- Renaming a *Template*
A new *Template* will automatically be named after the *Task* it was created from. This name can be edited.

- Open the *Template* option menu
- Move the highlight to <Rename>
- Press <OK> and the *Rename* form will be shown; this is similar to the *rename* form of the *Project* (Figure 19)
- Keep the cursor in the name box and press <OK> to bring up the keyboard emulator (Chapter 3.6.2 *The Keyboard Emulators*)

4 THE INSTRUMENT

Settings and information specific to the instrument are handled in the *Instrument Menu Item* of the *Navigation Menu* (Figure 29). Each *Sub-item* is explained below.



Figure 29 Navigation menu: Instrument Menu Item: Storage Sub-item marked

4.1 Data Storage

The *Instrument/Storage Page* (Figure 30) shows information about the data storage.

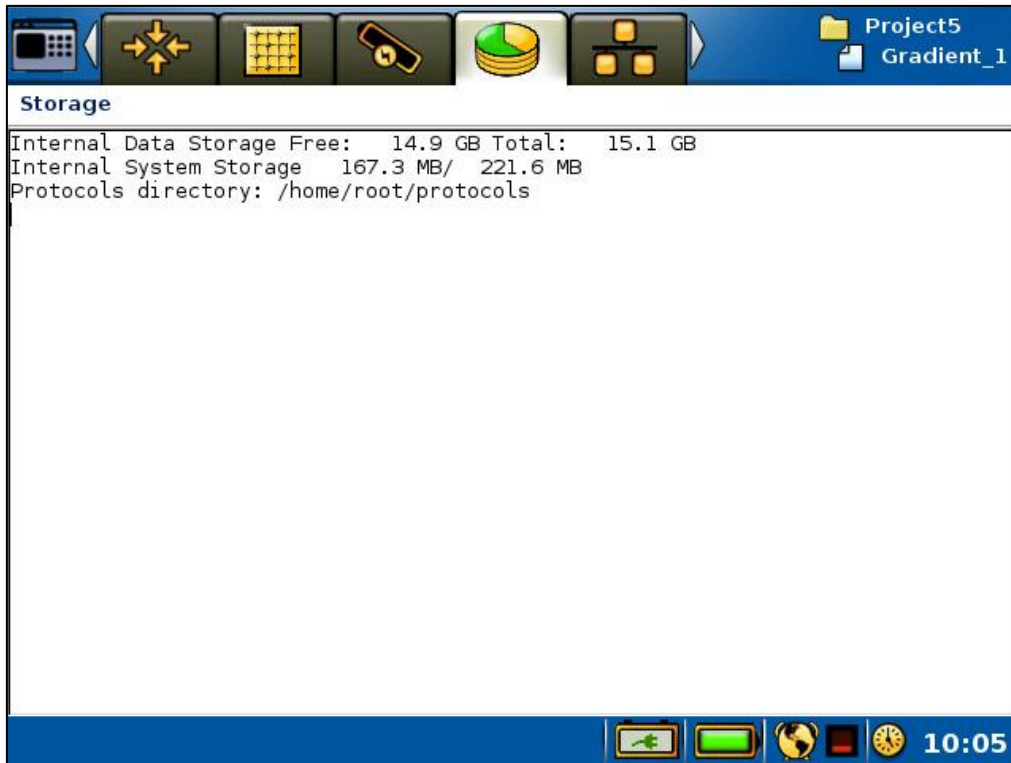

Figure 30 Information Page for data storage

4.2 Network Connections

The Terrameter LS 2 has three network modes;

- LAN Client
- LAN Server
- Wi-Fi Access Point

From the *Instrument/Network Page* (Figure 31) it is possible to change between the network modes and get network information. The *Network Page* will also show information about connected external electrode selectors (ES10-64C).

The *Network Page* displays the instrument's IP address, labelled "eth0"; this used to communicate with the instrument via VNC software (see Chapter 3.3 *VNC Control*) or when using Terrameter LS Toolbox (see Appendix D. *Terrameter LS Toolbox* overview) for downloading data, managing protocols and spreads, and/or instrument maintenance. If the instrument is in "LAN Client" mode and the server it is attached to has an internet connection, the Terrameter will try connecting to the ABEM technical support server via a Virtual Private Network (VPN, see Chapter 8.5 *Remote Diagnostics*). If successful, the VPN tunnel address will be listed, and labelled as "tun0".

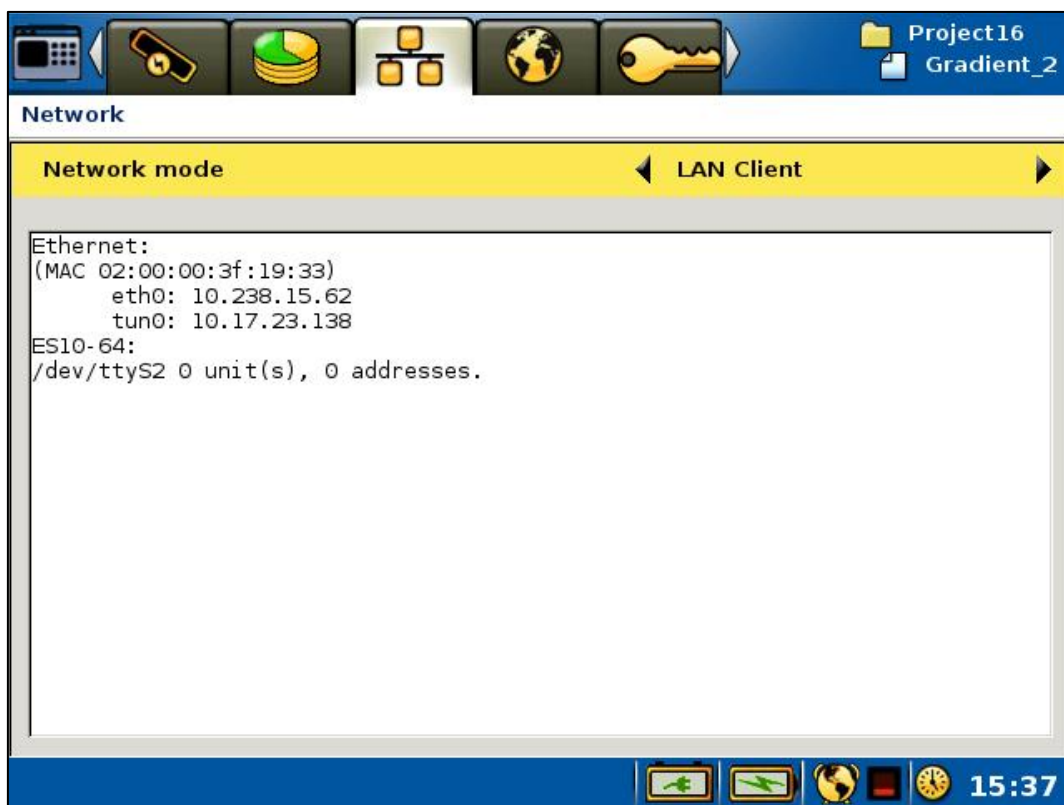

Figure 31 Network Page

Note!

The information text on the Network Page will update automatically for LAN Client mode, but it will not update automatically when switching between network modes. To get updated network information it will be necessary to go to another *Page* temporarily. An easy way is to press <Browse> to go to the *GPS Page*, wait for a few seconds, and then press <Shift> + <Browse> to go back to the *Network Page*.

4.2.1 LAN Client

In LAN Client mode, the network the Terrameter is attached to should supply connected clients with an IP address. Such devices are typically routers or servers, which act as DHCP servers, and this type of network is very common for office and home networks.

4.2.2 LAN Server

It might often be useful to connect a computer directly to the instrument. For this to work the DHCP server in the Terrameter LS 2 must be activated from the *“Instrument/Network” Page*. The sequence in the following procedure is critical to avoid failed connections:

1. Make sure that no network cable is connected
2. In the *“Instrument/Network” Page* select *“LAN Server”*
3. Go to the *GPS Page* by pressing <Browse>
4. Wait for a few seconds
5. Go back to *Network Page* by pressing <Shift> + <Browse>
6. Check that the eth0 address is 192.168.23.1
7. Connect the PC and the LS with an Ethernet network cable
8. Wait until the PC has received an IP address
9. Perform all required activities using Terrameter LS Toolbox, VNC software etc.
10. Disconnect the Ethernet cable
11. On the LS set DHCP server to Off
12. Turn off LS

Warning! Before connecting to an office network, be certain that the Network mode on the **Terrameter LS 2 is NOT set to LAN Server**. If an instrument with the *LAN server* mode activated is connected to a network with another DHCP server in operation it can create severe network clashes seriously affecting other network users.

4.2.3 Wi-Fi Access Point

In this network mode the instrument will act as a wireless access point. This makes it possible to connect a computer or mobile device directly to the instrument without using any cables, a feature that can be very convenient to download or backup data in the field or VNC viewing and control (see Chapter 3.3 *VNC Control*). The instrument will create a wireless network with the same name as the instrument serial number, e.g. *“LS216080369”*. The password for the Wi-Fi network is *“TerrameterLS2”*.

Note! When starting the Wi-Fi Access Point network mode it may take 1 - 2 minutes before the wireless access point is started.

Note! The SSID of the wireless network will be the same as the instrument serial number, e.g. *“LS216080369”*. The password for the wireless network is *“TerrameterLS2”*

4.3 GNSS (Global Navigation Satellite System) Receiver

The *GPS Page* (Figure 32) shows a live status for the GNSS receiver and the present position of the instrument, provided a sufficient satellite signal is received. The default mode for the Terrameter is to use the Internal GNSS antenna mounted in the handle of the instrument. However, an option to receive GNSS positioning from an external device is available. External positioning systems can provide better station records during static measurements or help facilitate mobile measurements.

To use an external positioning device, set it up to output positional information as an NMEA string in GGA format via a USB cable. Plug the USB cable into the USB port on the end panel of the Terrameter LS 2, and use the left or right arrow to select *External GPS*.

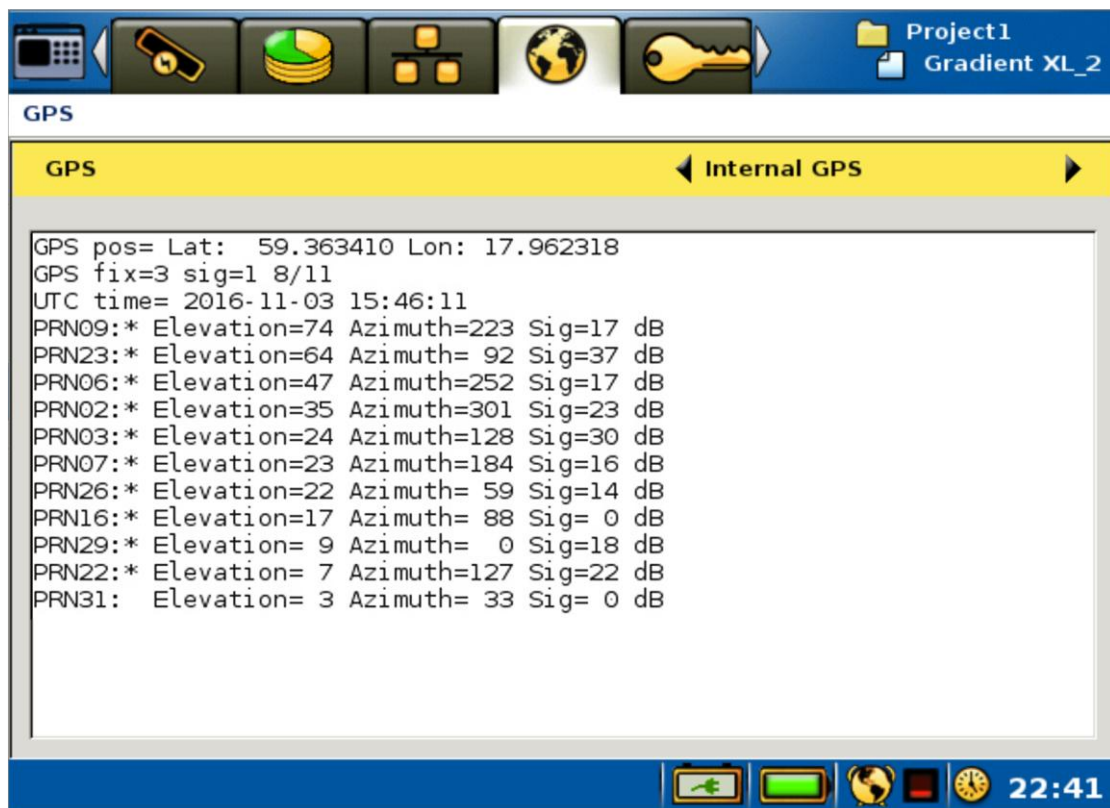

Figure 32 Status Page for GPS receiver

There is no need to use a specific external GNSS device, the only requirement is that the GNSS device is able to output a GGA formatted NMEA string via USB at a rate of 1Hz or 2Hz. The Terrameter will automatically apply the correct serial communication settings but, if positional information fails to appear, start by ensuring that the external device is transmitting and then check its communication settings:

- Baud rate:** any value from 9600 to 115200
- Data bits:** 8
- Stop bits:** 1
- Parity:** None
- Flow control:** None

4.4 Language

It is possible to change the language used for the main instrument menus, dialogues and data displays from the *Language Page* (Figure 33).

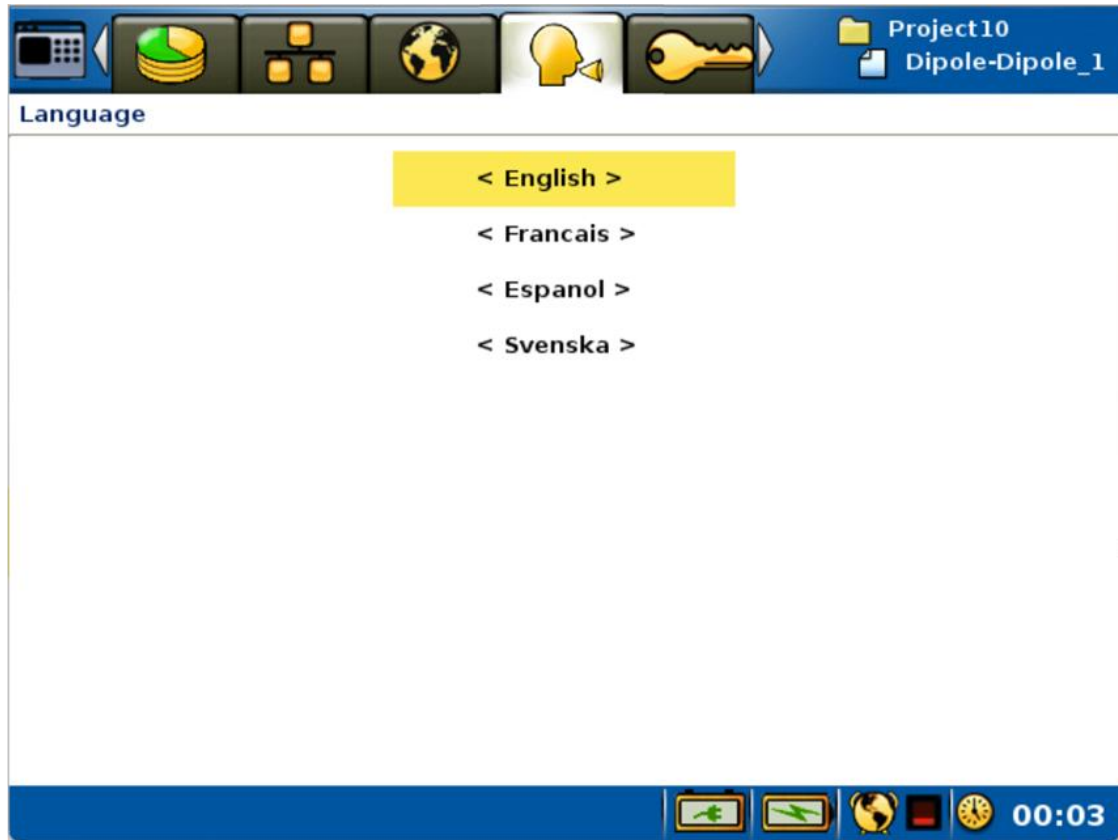

Figure 33 Language Page

The conversion from one language to another is not instantaneous and requires a reboot of the instrument (Figure 34) to take effect.

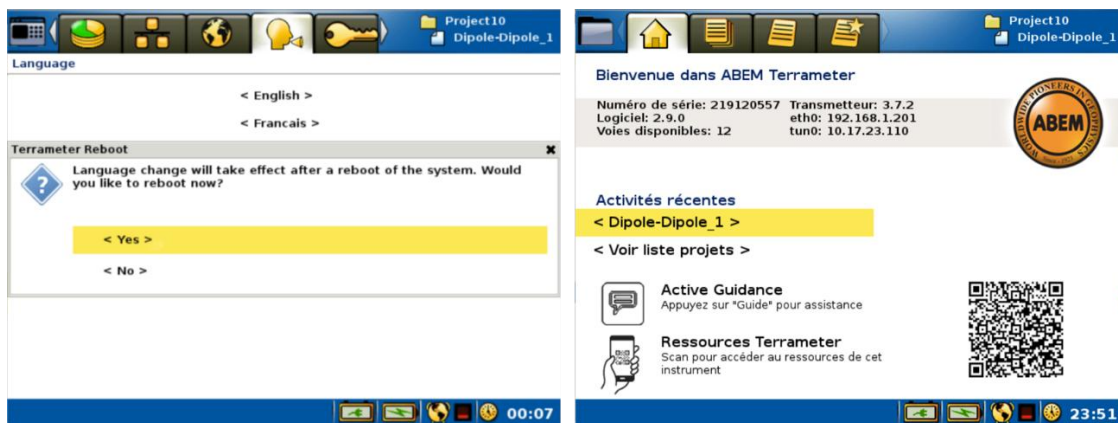

Figure 34 Confirming a reboot of the Terrameter LS 2 to change display language

Note! Note that, at present, Active Guidance screens are only available in English.

4.5 License

The *License Page* (Figure 35) shows the current state of the license and all activated features. It is also possible to update the instrument's license from this page if an upgrade has been purchased and made available. These license updates can be installed over the internet if the instrument is connected to the ABEM technical support site (see 4.2 *Network Connections*). Alternatively, if connecting the instrument to the support site proves problematic, licenses can be updated from a USB memory stick. In such a case contact the Guideline Geo support team to receive the license file.

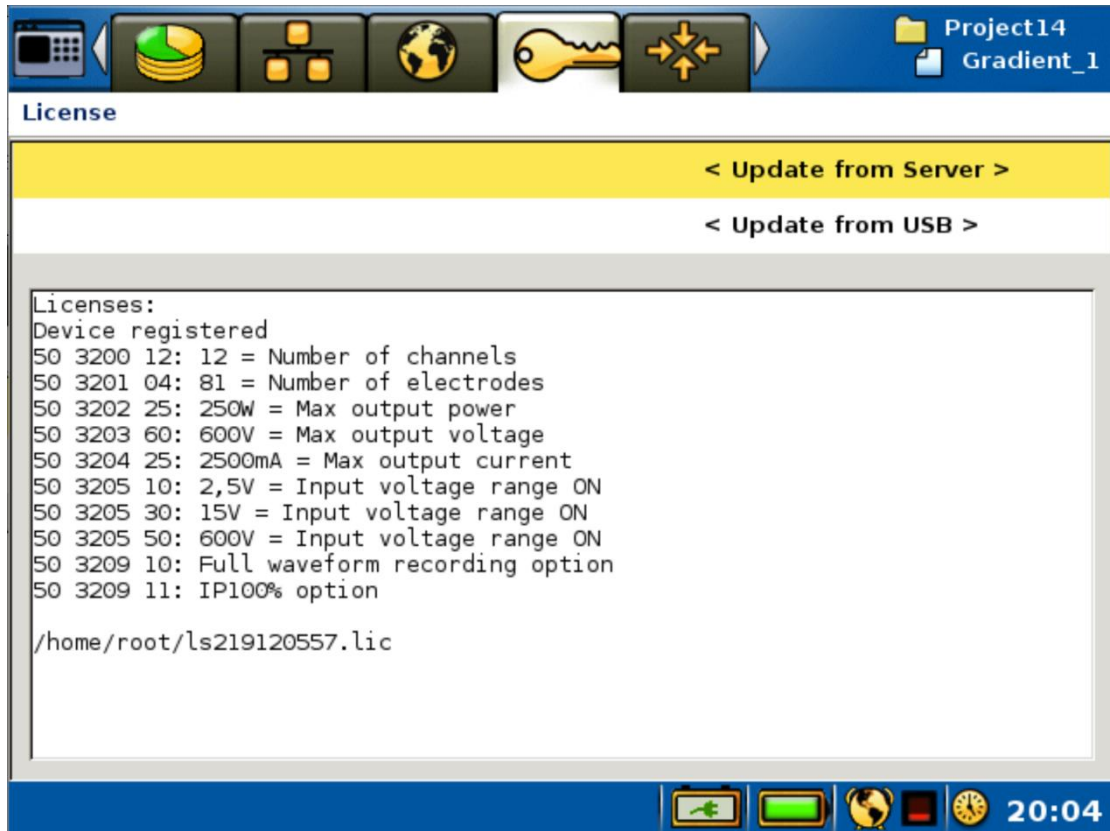

Figure 35 License status Page

After selecting the appropriate update option, the License update dialog (Figure 36) will show. After the update is finished the license update dialog will disappear and the licenses on the License status Page will update. In some instances, it may be necessary to restart the instrument for the changes to register.

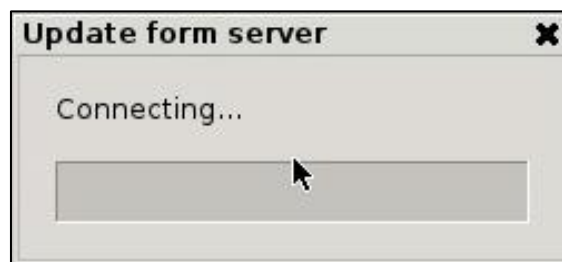

Figure 36 License update dialog

Note! Updating the license may take up to 2-3 minutes. During this period the screen will not change.

4.6 Calibration

Calibration of the instrument is done at the factory before delivery. Users have no need to access this page. An unlock key must be typed in to access the content (Figure 37), and a complete calibration requires special equipment. If you suspect your Terrameter LS 2 requires recalibration (it is unlikely to be necessary during normal operation), contact support@guidelinegeo.com

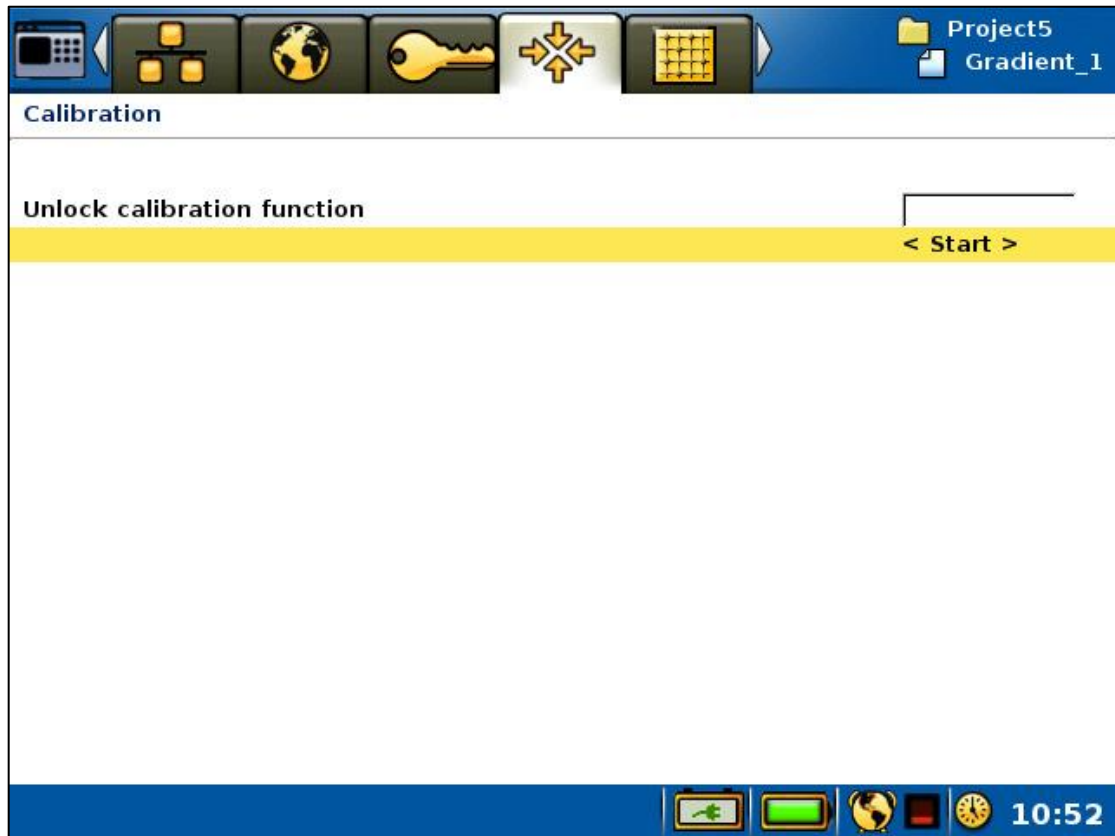

Figure 37 Calibration Page

4.7 The Relay Switch

The relay switch consists of four relay cards that can handle 16 electrodes each. The VES MAX version of the instrument has one relay card. The relay switch can be re-configured by an optimization routine in the instrument software depending on how many measuring channels the instrument is equipped with. This design allows measurement with many receiver channels without having a prohibitively large relay switch¹. The design chosen here provides a good compromise between capability vs. physical size and cost, and is suitable for multi-channel measurements.

For a 2 or 4-channel instrument it is possible for each measuring channel to measure on an arbitrary electrode pair between 1 and 64 with no restriction. For an instrument with 8, 10 or 12 measuring channels, the channels will be distributed in the relay switch by an optimization algorithm, and the efficiency of use of the channels will depend on which potential electrode

¹ For example, a regular matrix switch with full freedom in switching for 12 measuring channels and 64 electrodes would require 1664 relays, which would be bulky and expensive.

pairs are to be used for measurement during a given current transmission electrode pair. The instrument software optimizes the use of measuring channels so that as many measurements as possible are taken simultaneously for each measuring cycle, given the capability and limitations of the relay switch. The maximum efficiency is achieved if the electrodes of the receiver channels are distributed between the relay cards rather than all being concentrated to one relay card.

Input for the measuring channel optimization is what is written within a <Measure> section in the XML format measuring sequence (protocol) file (see Appendix C. *Spread and Measuring Sequence Files* for details). If all receiver pairs can be measured within one current transmission that will be done but, if necessary, measuring will be divided on two or more rounds of current injection. Hence, it is allowed to list more receiver combinations than there are measuring channels in the instrument within one <Measure> section.

The overall measurement efficiency will be dependent on a number of factors, for example, how many measurements there are per current electrode pair.

The present status of the relay switch can be viewed in a table on the *Electrode Switch Page* (Figure 38).

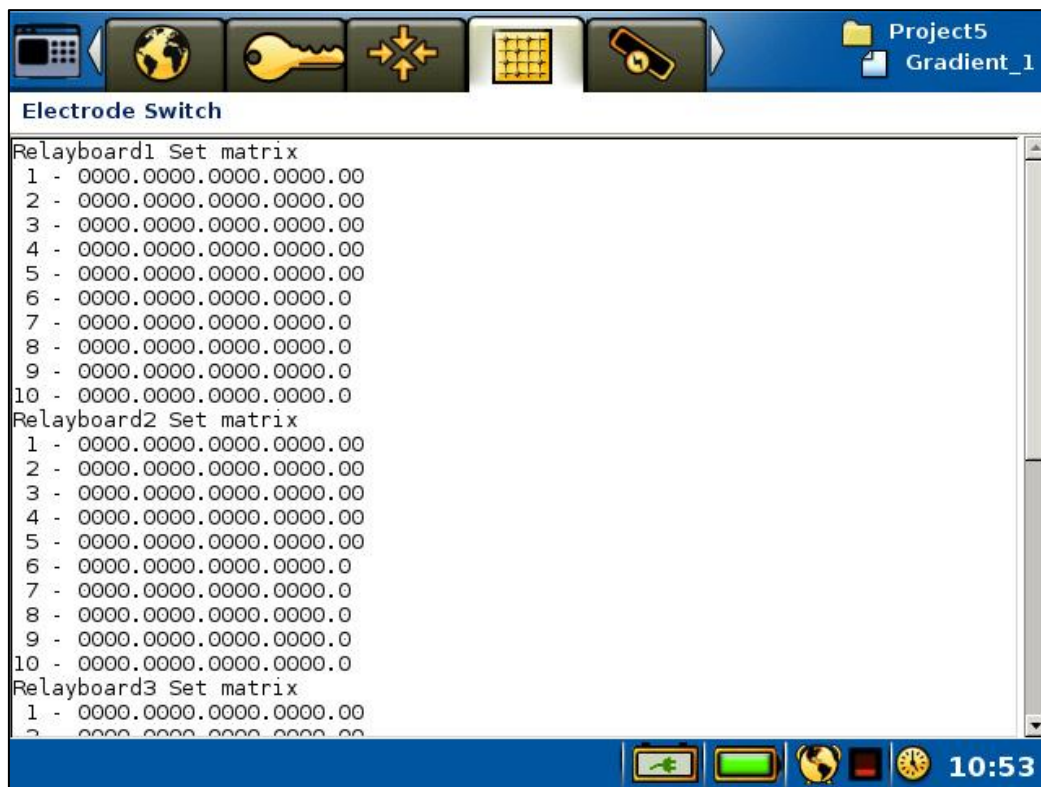

Figure 38 Relay switch status Page

4.7.1 The External Relay Switch(es)

If more than the internal 64 electrode switching capability is required, one or more external relay switching units (electrode selectors) of type ES10-64C can be connected. In cases where more than one external unit is required, they must be of type ES10-64C (orange colour), the older ES10-64 (grey colour) cannot link to other units.



Figure 39 An ES10-64C connected to a Terrameter via either ABEM Multifunction Cable, ES10-64C Communication Adapter and interlink cables, or Interlink Converter Set and interlink cables

There are several connection options for the ES10-64C depending upon the required layout and distances involved.

- If the distance between the Terrameter and the (first) ES10-64C is less than 1.5m, it should be connected to the AUX connector via a multifunction cable (ABEM part no 36-33002011) (Figure 39). The ES10-64C will take power direct from the Terrameter LS 2. Additional ES10-64C units will connect in series, using an “ES10-64C Interlink Cable” between them, and each will require external 12V power. The last ES10-64C in the chain cannot be more than 500m from the Terrameter LS 2.
- If the first ES10-64C needs to be more than 1.5m from the Terrameter LS 2, an “ES10-64C Communication Adapter” (36-33002281) plus an “ES10-64C Interlink Cable” is required. As above, the last (or only) ES10-64C in use cannot be more than 500m from the Terrameter. All ES10-64C units will require an external 12V power source connected by an “ES10-64C External Power Cable” (36-33002206).
- If larger distances are required the “Interlink Converter Set” (22-33001286) can be used. Only **one** ES10-64C can now be used, but the maximum distance between the Terrameter and ES10-64C is 2000 meters. The ES10-64C requires an external 12V power source.

Note! Depending upon conditions, some older ES10-64C units can experience a start-up issue where they consume more power (12V DC) than expected. This can be solved by using external power, or by doing a minor hardware modification of the ES10-64C controller board. Please contact ABEM in case you experience this problem.

Instrument software version 1.5.1 or higher is required to use an external relay switch. The software will attempt to connect with the ES10-64C at measuring start, provided the selected spread and protocol file demands an external relay switch. The spread files must hold information about the external switching unit, as described in Appendix C. *Spread and Measuring Sequence Files*.

4.8 Power Source

The *Power Source Page* (Figure 40) shows the status for the power supply and internal temperature of the instrument. The actual values are shown and they are complemented with minimum and maximum values (since start-up) within square brackets.

The screenshot shows the current design with two Li-ion batteries forming the internal power solution. For older instruments with a single NiMH battery, there is a single “Battery status” read-out and only one internal battery icon in the notification area at the bottom of the screen.



Figure 40 Status Page for power supply and temperature

The ABEM Power Adapter (10-006021) is a useful way to ensure a good power supply for your Terrameter LS 2; this optional accessory allows the Terrameter to be run from a small mobile generator. It is a rugged AC-DC converter which is able to cope with fast-changing and, often, high-current demands of the Terrameter during measurement, whilst still providing a stable 12V supply.

5 MEASUREMENT PREPARATION

5.1 Save Field Time With Good Preparation

Successful surveys start in the office; look through archive material for the area (topographical and geological maps, aerial photographs, reports etc.) and consider whether resistivity surveying is a suitable method for the current problem. If so, select possible profile line locations that are likely to be most diagnostic / provide the greatest chance of success.

Once on site, walk around the area to be surveyed with maps and/or aerial photographs at hand to select the optimal profile lines; current conditions, or features only obvious when on site, may change your original plan. Walk the entire length of any planned profiles before putting out any equipment, to ensure that the selected lines are practical.

Note! Poor electrode contact is the most common reason for bad data.

Bring suitable hammers for installing the electrodes in the field, for instance polyurethane (PUR) covered hammers that give good force without damaging the electrodes. It is often necessary to water the ground around electrodes, sometimes with addition of salt and/or some additive to make the water stay in place during measurements (for instance drilling polymer or bentonite). In cases with paved surfaces it may be necessary to drill holes for inserting the electrodes or use plate electrodes.

Electrical installations and grounded metal objects may disturb the measurements and create noise, be observant and take notes of possible sources of disturbance.

5.2 Preparing for Data Acquisition

5.2.1 Create Projects and Tasks

In order to prepare for data acquisition, at least one *Project* with one or more *Tasks* must exist. Chapters 3.7.1 *Project* and 3.7.2 *Task* explain how to create *Projects* and *Tasks*.

Alternatively, measurements can be added to existing *Projects* and *Tasks*.

All data from a *Project* is saved in a single database file. It is recommended not to make the *Project* too large as it may become cumbersome and slow to handle. In large data acquisition campaigns it may, for example, be suitable to make a new *Project* for every day in the field.

Also see Chapter 6.14 *Full Waveform Data* for more information about recording and handling larger volumes of data.

5.2.2 Data Acquisition Settings

Data acquisition settings are defined within the “Settings” Menu Item, under which there are five Pages: “Load/Save Settings”, “Receiver Settings”, “Transmitter Settings”, “IP Window Settings” and “Borehole Log Settings”.

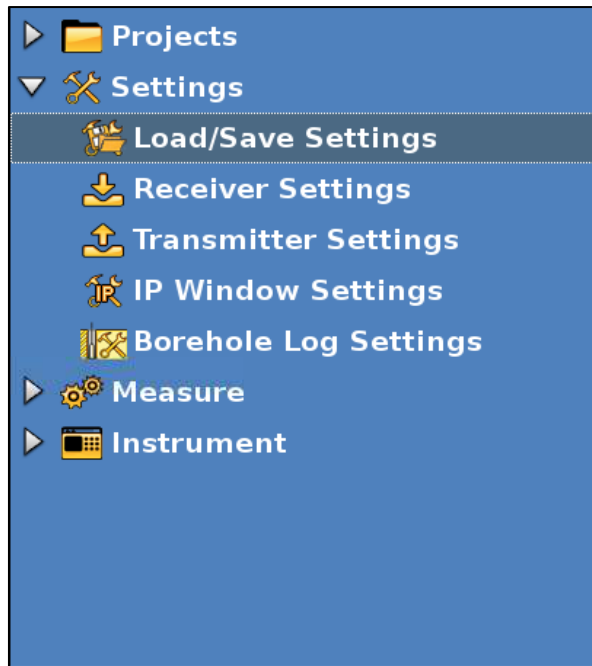

Figure 41 Navigation menu, Settings Menu Item: Load/Save Settings Sub-item marked

5.2.2.1 Load/Save Settings

The Terrameter instruments come with a set of pre-loaded suggested settings for different modes of survey. These settings should be suitable for starting the majority of surveys.



Figure 42 Load/Save Settings Page

The available options on the *Load/Save Settings Page* (Figure 42):

Load Settings	Load predefined settings
Save Settings	Save the current settings to a file
Delete Settings	Delete settings files

Settings files can be loaded to the instrument using Terrameter LS Toolbox, or saved directly on the instrument based on the current settings. If the pre-loaded settings files are lost or accidentally deleted, a new set can be downloaded from the Guideline Geo website.

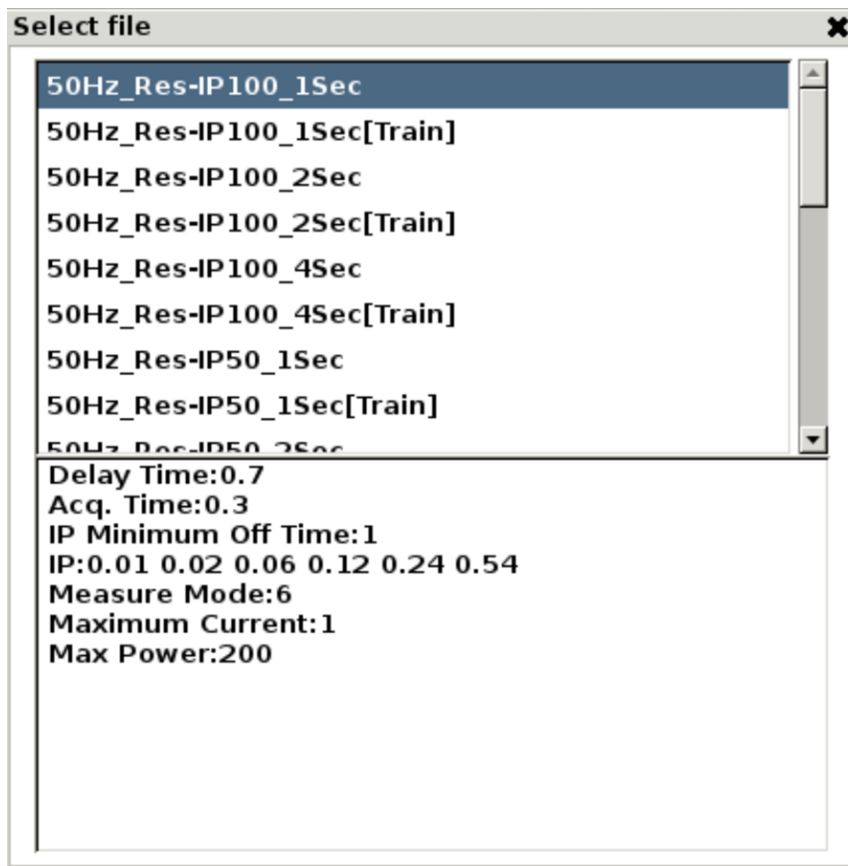

Figure 43 Load Settings dialog

The *Load Settings* dialog (Figure 43) is divided into two parts. The upper part lists the installed settings files. The lower part shows what settings will be changed compared to the current settings.

Note! Only the settings that will be changed compared to the existing setup are shown in the *Load Settings* dialog

The naming of the settings files supplied by ABEM starts with the regional electricity transmission frequency, followed by the measurement mode and then information about the settings. For example:

“50Hz_Res-IP50_1Sec” activates a RES and IP *Measure Mode* (using 50 % duty cycle), with 1 second ‘on time’, and IP windows optimized for 50 Hz power line frequency.

“50Hz_Res-IP100_4Sec[Train]” activates a RES and IP *Measure Mode* (using 100 % duty cycle), with 4 second ‘on time’, IP windows optimized for 50 Hz power line frequency, and filtering noise from train networks operating on 16.67 Hz (found in since northern European countries). Note that the 60Hz version of this script filters train networks operating on 25 Hz (found on some AmTrak lines in the northeast of the USA).

“50Hz_Res_0.3+0.5Sec” activates a RES *Measure Mode*, with 0.3 second delay time, 0.5 second acquisition time, and optimized for 50 Hz power line frequency.

5.2.2.2 Receiver Settings

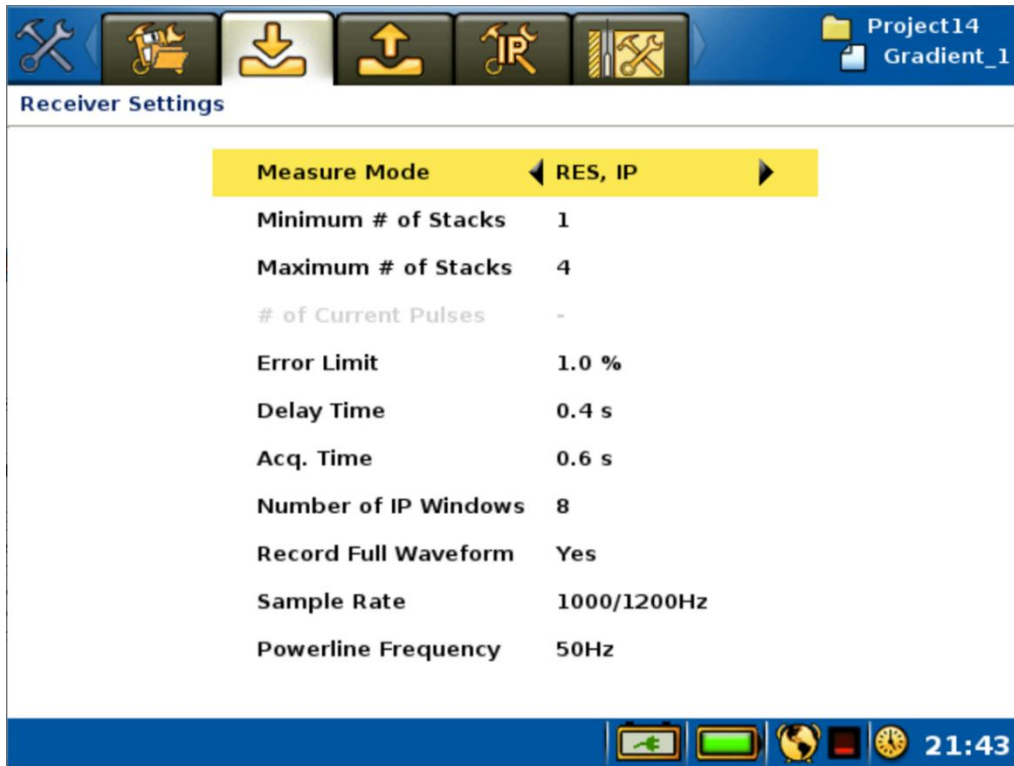

Figure 44 Receiver Settings Page

The available settings on the *Receiver Settings Page* (Figure 44):

Measure mode Options include Self Potential (SP), Resistivity (RES), combined Resistivity and Induced Polarization (RES, IP) using traditional 50 % duty cycle current pattern, and a novel combined Resistivity and Induced Polarization (RES, IP100%) mode using 100 % duty cycle (only available on LS 2 Advanced and VES MAX models).

Minimum # of Stacks Active for “Res, IP” and “SP mode; the number of stacks needed will depend on site conditions, electrode spread size and the type of electrode array used. It is recommended to start out a task with multiple stacks and, if the standard deviation is very favourable, the maximum number of stacks setting may be reduced even as low as one to speed up measurements. The total number of stacks used will depend upon whether the error criteria has been met (see “Error Limit”, below) or the maximum number of stacks has been achieved.

Maximum # of Stacks

# of Current Pulses	Active for “Res, IP100%” mode; defines how many current pulses will be used per measurement, this number is not constrained by data quality (“Error Limit”). Only available on LS 2 Advanced / VES MAX models.
Error Limit	The error limit is equivalent to the standard deviation between repeated measurements (stackings) divided by the mean value for a data point, also known as variation coefficient. Measuring will be repeated until the minimum number of stacks has been achieved. Measurement for that data point will then stop if the variation falls within the specified limit. If not, it will continue until either the variation drops below the limit or the maximum number of stacks has been reached.
Delay Time	The delay time setting defines the interval from switching on current transmission until signal integration for the resistivity measurement starts. Ideally the delay time should be long enough for the ground to become fully charged. If set too short, charge-up effects within the ground may decrease data quality.
Acq. Time	The acquisition time defines for how long signal integration lasts for each part of the measuring cycle (see Appendix A. <i>Measurement Modes</i>). Generally the principle is that the longer the acquisition time, the better the data quality. It should be noted, that in some countries the railway system uses a frequency of $16^{2/3}$ Hz, which means that multiples of 60 ms are required (note that such noise may be observed many kilometres or even tens of kilometres away from railway lines).
Number of IP Windows	The number of IP windows only applies to measurements in one of the IP modes, and the timings are defined in the “ <i>Measure/IP Windows Settings</i> ” Page (Figure 46).
Record Full Waveform	In addition to the single averaged data values measured for each electrode combination, this option records how the output voltage and current, plus the input voltages, change throughout the measurement cycle (LS 2 Advanced / VES MAX models only). This option does not increase measurement time, but it does create bigger project files, especially at high “Sample Rate” settings. See Chapter 6.14 <i>Full Waveform Data</i> for more information on this issue.
Sample Rate	Specifies frequency at which full waveform measurements are sampled. A higher sample rate means that more samples will be used for data calculations, and can be especially useful for IP data
Powerline Frequency	The power line frequency should be set to 50 Hz or 60 Hz depending on the system used in the area of investigation and is used to adjust measurement parameters for filtering of power line noise.

5.2.2.3 Transmitter Settings

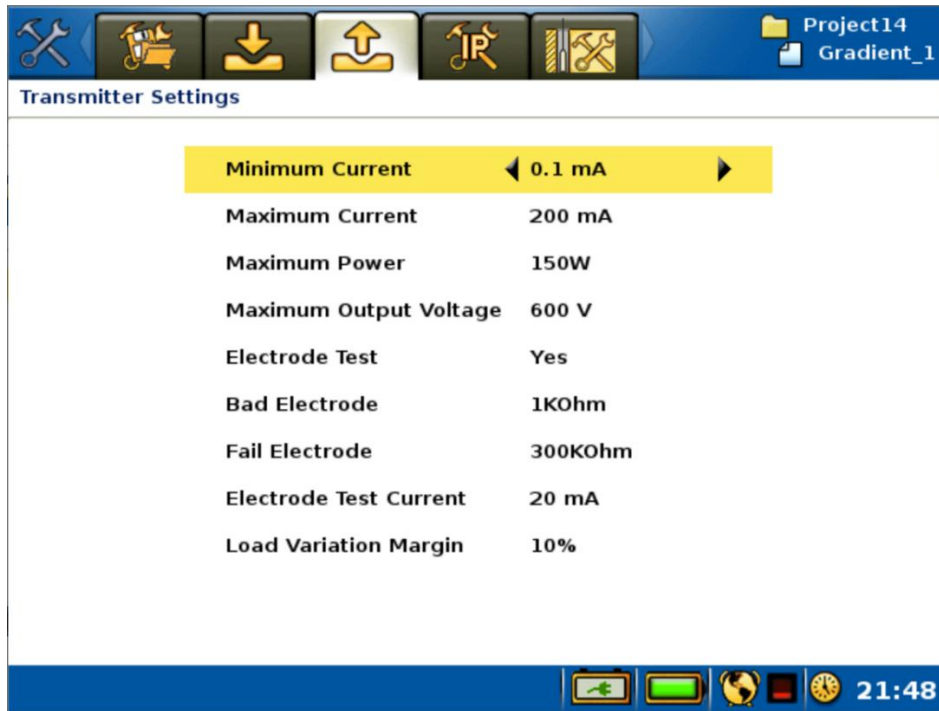

Figure 45 Transmitter Settings Page

The available settings on the *Transmitter Settings Page* (Figure 45):

Minimum Current	This setting does not force the instrument to transmit, at least, the selected current (the actual value is a result of ground conditions and the maximum current/voltage/power settings); instead, this defines when a “low current” warning will appear.
Maximum Current	Sets the maximum current that can be used for measurements. It should be selected according to site conditions (electrode grounding conditions, noise levels etc.), electrode spread size and type of electrode array, to achieve good signal-to-noise ratio and productivity. Setting the maximum current to a lower than maximum value can be used for saving battery power
Maximum Power	Maximum output power can be limited, for example to save battery power
Maximum Output Voltage	Maximum output voltage from the transmitter can be limited, if for example the electrode cables used are not designed for the maximum voltage
Electrode Test	Electrode test is carried out using the ‘Focus One’ method, in which the resistance of each electrode is measured against all the other electrodes combined; this option determines whether the test will be done. Switching it off is not recommended for normal data acquisition as it may lead to the acquisition of bad data from electrodes with inadequate ground contact.

Bad Electrode	Thresholds for categorizing acceptable electrode contact resistance.
Fail Electrode	Needs to be set according to site conditions, as ground resistance can vary a lot from site to site.
Electrode Test Current	The maximum current used for the electrode test. 20mA is normally a good value to use.
Load Variation Margin	This defines how much the output voltage is allowed to change in order to maintain constant current (if the load varies) during measurement. If the change is bigger than the set value, the measurement will stop, and an error message shown (typically "Not regulating"). The default value is 10 %. Increasing this value can improve measurements in difficult conditions but will also limit the maximum power output as the instrument must maintain a larger 'reserve' of power at the start of a measurement (to be able to maintain constant current flow in the case that load resistance increases during the current injection).

5.2.2.4 IP Window Settings



Figure 46 IP Window settings Page

The timing setup for measuring chargeability in IP *Measure Modes* is defined in the "IP Window Settings" Page (Figure 46). Integration times for the (up to) 20 measurement windows are entered in the bottom list. The 'current-off' time (only relevant to the traditional, 50% duty cycle, "IP" *Measure Mode*) is equivalent to "IP Minimum Off Time" unless the total sum of IP delay time and integration times are larger. IP integration windows should be multiples of the local powerline frequency period (for instance multiples of 20 ms for 50 Hz frequency and 16.667 ms for 60Hz). "IP delay time" allows the natural noise generated when current is switched off (or switched polarity) to pass before integration begins; it should only be 0.01 s – 0.02 s.

5.2.2.5 Borehole Log Settings

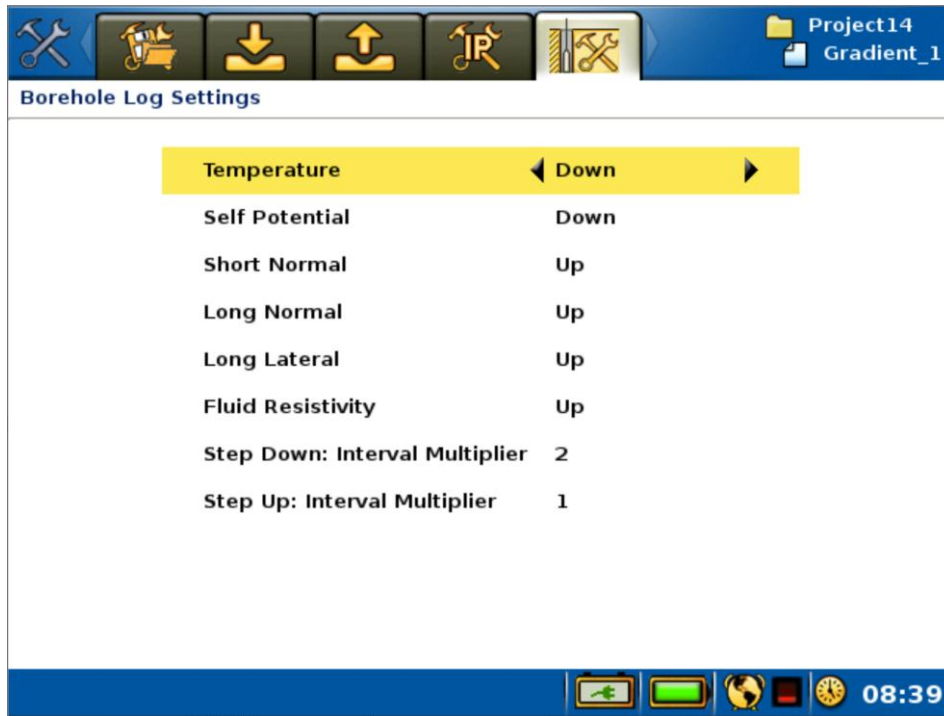

Figure 47 Borehole Log Settings Page

The available options on the *Borehole Log Settings Page* (Figure 47) are as follows:

Temperature This, and the next five menu items, represent the different parameters that can be recorded in borehole logging. These settings define if, and when, each of them will be recorded.

They can be set to “No”, “Up”, “Down”, and “Up and Down”.

Self Potential Normally recorded on the down phase, before any current flows.

Short Normal A resistivity/IP measurement of the surrounding geology.

Long Normal A resistivity/IP measurement of the surrounding geology.

Long Lateral A resistivity/IP measurement of the surrounding geology.

Fluid Resistivity A resistivity measurement of the fluid within the borehole.

Step Down: Interval Multiplier The default measurement interval (defined as the “Z” value when creating a *Task*, see Chapter 3.7.2 *Task*) can be given a multiplication factor for “Step Down” and “Step Up”, respectively.

Step Up: Interval Multiplier This allows different measurement intervals on the downward and upward journey of the logging device. For example, if the “Minimum Electrode Spacing Z (m)” was set to 1 m and the “Step Down” multiplier is set to 2, the borehole data will be recorded every 2 meters on the downward journey but every metre on the return, upward, phase. The multiplication result is called the *Step Distance*.

The multiplier can be set to 1, 2 or 4; default value is 1.

5.2.3 Create New Station

Before taking measurements in a new *Task*, it is necessary to create a new measurement *Station* (Figure 48); in the example, this will be the first station. A measurement station tells the instrument where the spread is located on the ground, i.e. translating the relative co-ordinates of the spread file to absolute positions. The *Station* refers to the location of the first electrode on the first cable of the active spread file, regardless of whether any electrodes or cables have been excluded on the “*Measure/Electrodes*” Page.

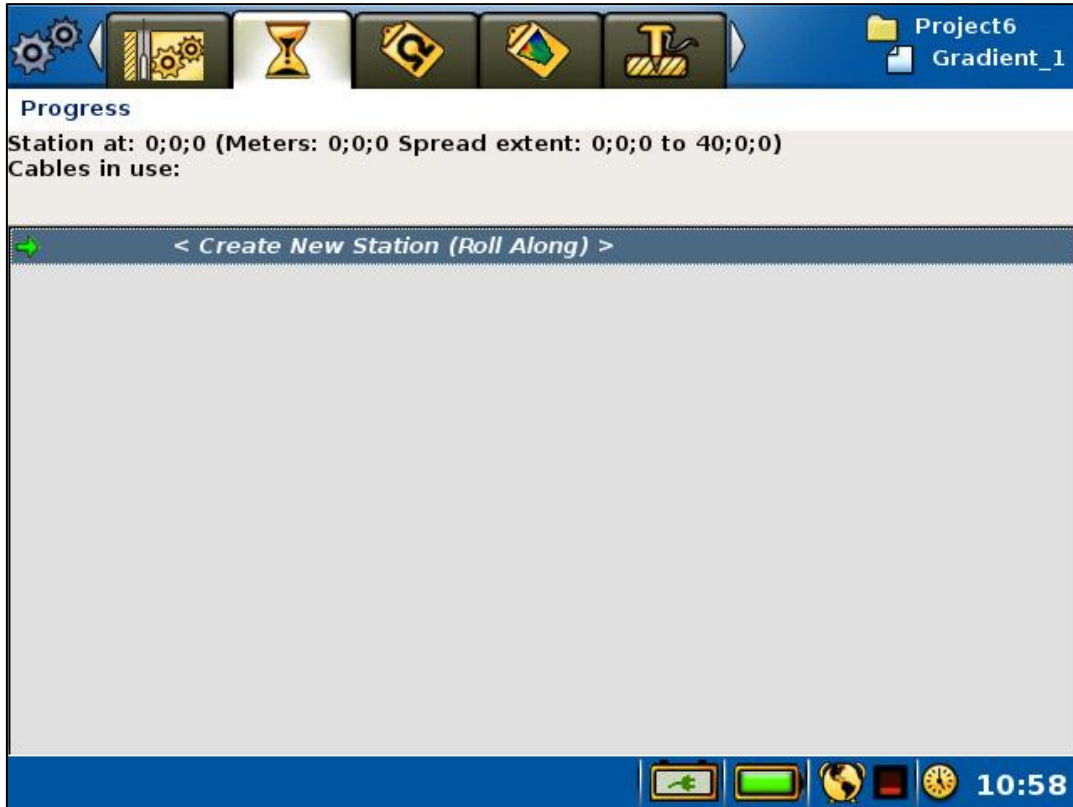

Figure 48 Create new station command on the measuring progress Page

The new station position is defined in the “Create New Station” dialog (Figure 49). To access this dialog, navigate to the “*Measure/Progress*” Page and press <OK> when the <Create New Station (Roll Along)> row is highlighted.

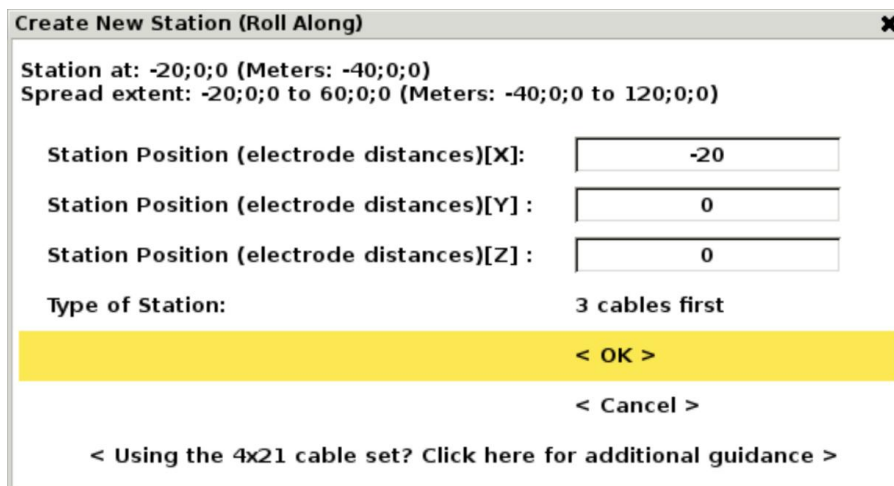

Figure 49 Create new station dialog

Note! Station coordinates are entered in 'relative electrode position' rather than absolute distance, i.e. take-out 1 is electrode position 0, take-out 21 would be electrode position 20, take-out 64 would be electrode position 63. This means that the sequence of Station Positions is the same for every survey using a given cable set, and independent of the electrode spacing used. True distance is the product of electrode position and electrode spacing.

The top of the dialog shows details of the spread layout for the currently entered coordinates, with station position at the top and total spread extent beneath. This information is shown as relative electrode position as well as in absolute distance in brackets. Positions can be entered manually or, alternatively, several pre-defined stations are available. The pre-set stations not only set the station position correctly, but also automatically exclude electrodes on cables not in use (where applicable). The pre-set stations are defined in the spread file. For more information on stationing for different cable sets see Chapter 6.5 *2D Electrical Imaging*, Appendix B. *Survey procedure for common cable sets*, Appendix C. *Spread and Measuring Sequence Files*, and/or the *Terrameter LS 2 Quick Start Guide* options available on the Guideline Geo website.

5.2.4 Cable and Electrode Exclusion

There may be occasions where there is not enough space to use all cables or electrodes within a spread, and it is necessary to use just a subset of the spread. In these instances it is possible to exclude using the "Measure/Electrodes" Page (Figure 5050).

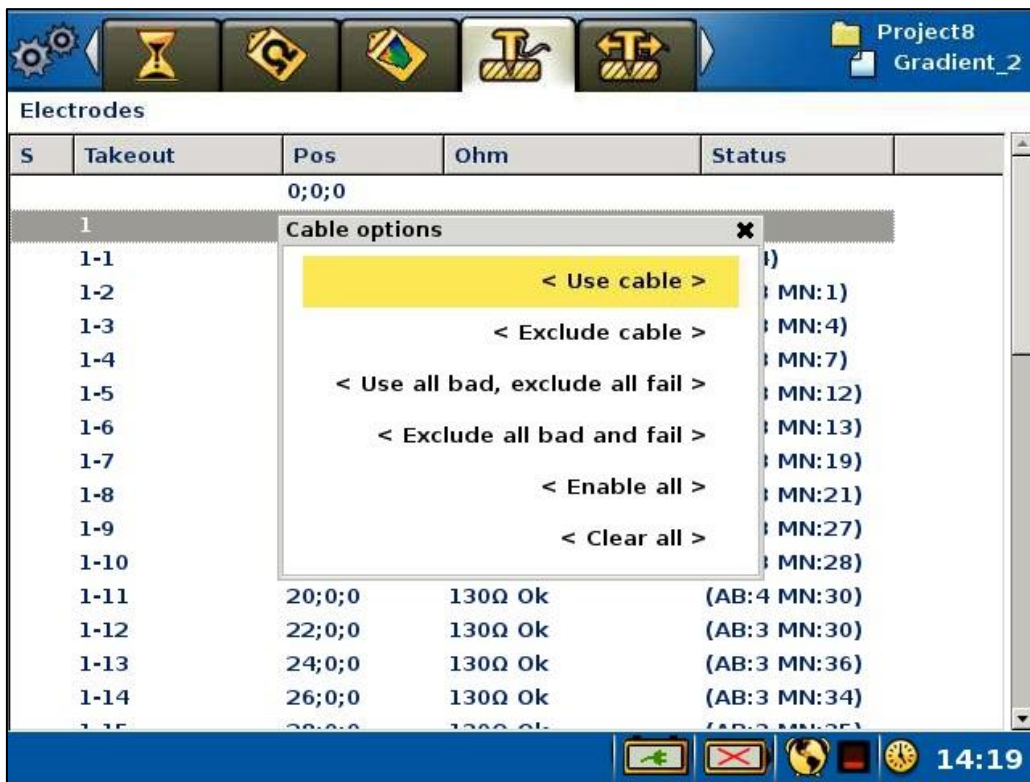

Figure 50 Exclude cable pop-up menu

- Excluding a cable / electrodes (also see Chapter 6.10.2 *Electrode Contact Test*)
 - Move the highlight to the required cable or electrode
 - Press <Options> and the option menu will be shown
 - Highlight the <Exclude cable> / <Exclude electrode> *Menu Item* (Figure 50)
 - Press <OK>

6 MEASUREMENT PROCEDURES

6.1 General

For general information and theory regarding geoelectrical imaging please consult a modern geophysical textbook or tutorial. This section focuses on the practicalities of using the Terrameter LS 2 resistivity meter and accessories rather than the in depth theory of resistivity and IP measurements.

Note! Moisture and/or dirt in the connectors will compromise data quality and may even cause permanent damage to the connectors or instrument. **Always keep the protective caps clean, dry and in place whenever possible. Interconnect the protective caps to protect each other when the cables are connected (Figure 51).**



Figure 51 Connecting the dust caps



Dangerous voltages and currents are transmitted by the Terrameter via electrode cables connected to it or an external Electrode Selector! During the entire duration of an electrode contact test or measurement session it is always the responsibility of the operator to have full control of the entire electrode cable layout, so that people and animals do not get close to the electrodes and electrode take-outs connected to the measurement cables!

6.2 Essential Equipment

The following equipment should be considered mandatory for data acquisition using the ABEM Terrameter LS 2 system:

- To ensure proper function during geoelectrical imaging with medium to high power the Terrameter should be powered from an external battery, for instance a gelled lead-acid battery or a car battery (55 – 70 Ah).
- Multi-electrode Imaging spread cables and suitable quantity of cable joints and cable jumpers.
- Suitable quantity of electrodes.

Double check that the internal and external batteries for the Terrameter are charged before going to the field!

6.3 Recommended Additional Equipment

Often additional equipment is required for efficient acquisition of good quality data. The following list is an attempt to summarize frequently needed additional equipment:

- Battery charger and spare external battery.
- A set of walkie-talkies, or mobile phones, if cables with long electrode take-out spacing are used (e.g. more than 2 meters between each take-out).
- Polyurethane hammers (two or more) for hammering in electrodes.
- Plastic bottles for water, potentially with added salt and viscosity increasing polymer, to improve electrode contact in dry ground. A drill mud polymer added to the water can increase the viscosity to prevent draining away during measurement in permeable soils. Mix salt and polymer with water to suitable viscosity, it may be wise to do this in buckets before pouring the mixture into plastic bottles of a convenient size.
- An additional quantity of electrodes and jumpers when operating in areas with dry ground giving contact difficulties, to allow use of multiple electrodes at a single take-out.
- Spray paint and pegs to mark out profile lines.
- Non-metallic surveyors' tape to measure distance from profile line to reference objects, or to measure electrode spacing if smaller intervals than the regular take-out spacing are to be used.
- Levelling equipment and / or good quality GPS receiver if topography needs to be recorded (depends on type of terrain).
- Remote electrode cable(s) if the pole-pole or pole-dipole array is to be used.
- A basic kit for keeping connectors clean and dry, for example toothpicks, toothbrush, lint-free cloth, and residue-free contact cleaner.
- Pocket multi-meter with continuity check function for error detection.

6.4 Setting up the Hardware

Roll out the electrode cables and connect the electrodes to the electrode cable. Be careful to ensure that adequate electrode contact is provided, and the cable jumpers that connect the electrodes to the electrode cables are in good condition and properly connected. It is recommended to twist or slide the connector up and down while connecting, to remove dirt or oxide on the contact surfaces.

Connect the electrode cables to Terrameter LS 2, making sure to connect them in the right order in relation to the cable layout used. Please see Appendix A. *Measurement Modes* and Appendix B. *Survey procedure for common cable sets* for a more detailed description for different types of surveying / imaging.

Connect external power supply if needed, the built-in battery pack(s) may only be sufficient for small low power surveys. Switch on the instrument by pressing the power button.

The Safety Switch button must be released before measuring can start in order to allow current transmission.

6.5 2D Electrical Imaging

The following section describes the general procedure for 2D electrical imaging with some referencing of particular cable sets. For specific details on 2D survey using the most common cable sets available with the ABEM Terrameter LS 2, see Appendix B. *Survey procedure for common cable sets*. Alternatively, consult the ABEM Quick Start Guides available for download from the Guideline Geo website, either through the support section of the site or from the LS 2 product pages. It is also possible to scan the QR code on the Welcome screen of the Terrameter LS 2 to access resources specific to resistivity survey.

6.5.1 General Cable Layout

To begin, all imaging cables should be rolled out in the direction of the profile, that is with the takeout numbers increasing in the same direction that the coordinate numbers increase. Secure the free cable end at the point of the low coordinate number end of the intended profile and walk the reel towards points of higher coordinate numbers (Figure 52). It is a good rule to have the profiles always running south-to-north or west-to-east (instead of north-to-south or east-to-west) to avoid confusion when the results are presented (unless an existing co-ordinate system demands otherwise)

2-Cable Layout

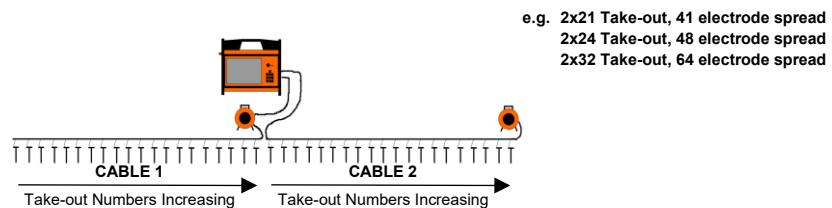

4-Cable Layout

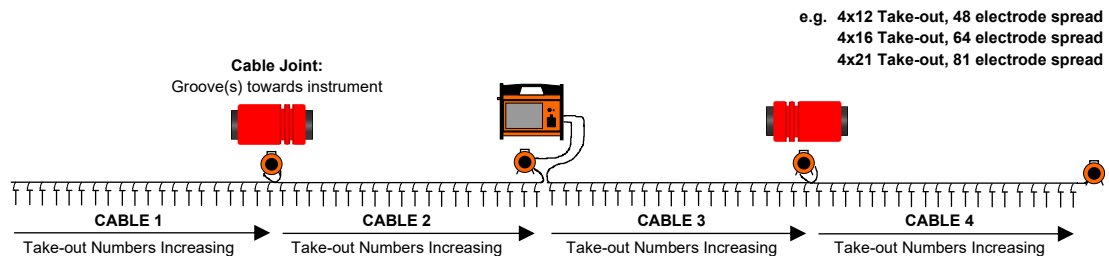

Figure 52 Generic cable arrangement for 2- and 4-cable layouts

6.5.2 Cable Joints

For all standard 4-section cable sets (4x12 electrodes, 4x16 electrodes, 4x21 electrodes) it is necessary to connect the outer cables (Cable 1 and Cable 4) back to the instrumentation through the inner cables (Cable 2 and Cable 3). This is achieved using a specific *Cable Joint* matched to the type of cable set in use. The cable joints are directional but have grooves milled into the body to assist with fitting them in the correct orientation.

Note! Groove(s) on cable joints should always point towards the instrument.

The number of grooves on a cable joint, identifies which cable set it is designed to work with. One groove indicates that the cable joint is for 4x21 cable set, two grooves for the 4x16 cable set and three grooves for the 4x12 cable set (Figure 53).

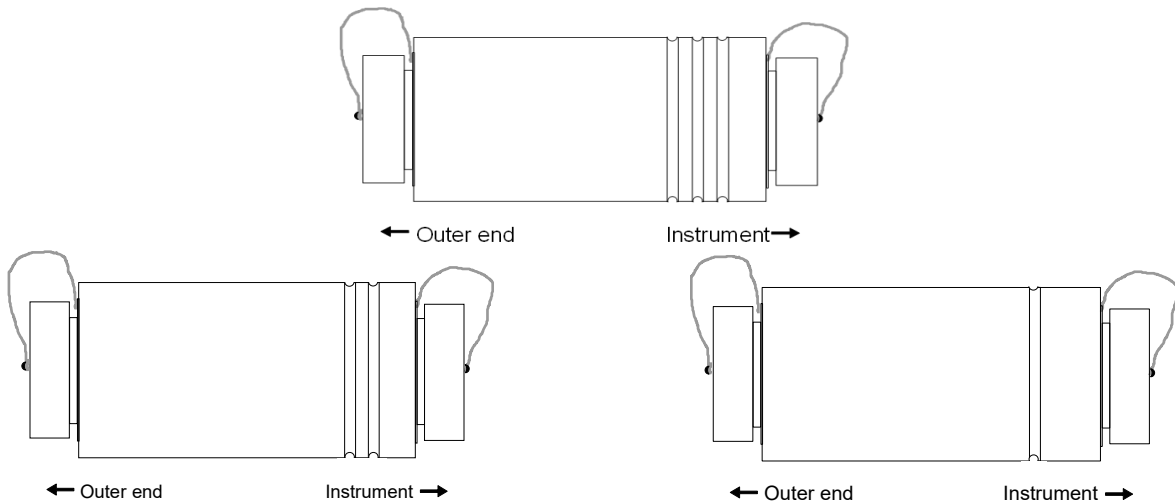
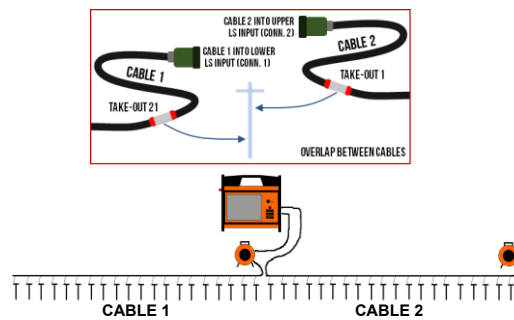

Figure 53 Cable joints with connection direction for 4x12 take-out cable set (top), 4x16 take-out cable set (left) and 4x21 take-out cable set (right)

6.5.3 Take-out Overlap on 21 Take-out Cable Sets

The layout of cables and electrodes differs slightly between the 21 take-out cable sets (2x21 and 4x21) and the other standard configurations (12, 16, 24 and 32 take-out cables). With the 21 take-out cables, Take-out #21 on Cable 1 overlaps with Take-out #1 of Cable 2. This is repeated at every cable joint and in the centre of the layout (where the instrument sits). These overlapping take-outs connect to the same electrode (see Figure 54). On all other cable sets, there is no overlap and the gap between the last take-out on one cable and the first take-out on the next cable should match the take-out spacing on the cables.

2x21 Cable Layout



NOTE: There is no overlap or shared electrodes on the following cable sets:

- 2x12 (24 electrodes)
- 2x16 (32 electrodes)
- 2x24 (48 electrodes)
- 2x32 (64 electrodes)
- 4x12 (48 electrodes)
- 4x16 (64 electrodes)

4x21 Cable Layout

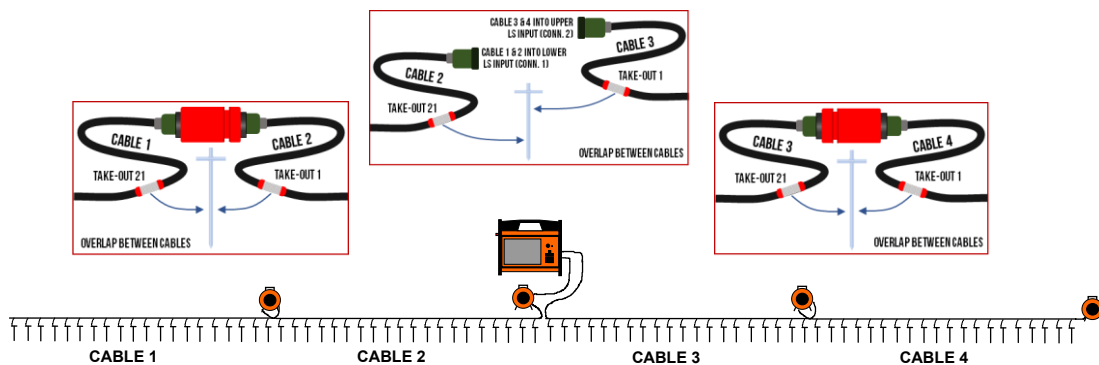

Figure 54 Cable overlap and electrode sharing on 21 take-out cable sets

The overlapping design also means there is no need to physically measure the distance between cables, it is only necessary to align the last and first take-outs of successive cables.

6.5.4 Connecting Electrodes, Spread Cables and the Instrument

Connect electrodes to all active take-outs. If the ground is soft and moist the electrodes can just be pushed into the ground by hand and connected; however, hammering and wetting is often needed for firmer, drier surface materials. Electrodes should be vertical and not inserted more than 1/10th of the electrode spacing (i.e. for 1 metre spaced electrodes, they should not be hammered in any deeper than 10 cm).

Check the contact surfaces between electrode take-outs, cable jumpers and electrodes for dirt and oxide, which can reduce data quality, and clean if needed. Link together inner and outer electrode cables using the cable joints.

On a 2-cable layout connect the Terrameter LS 2 between Cable 1 and Cable 2; Cable 1 goes into Connector 1 on the end-panel of the Terrameter LS 2, whilst Cable 2 goes into Connector 2. For 4-cable configurations, connect the instrument between Cable 2 and 3 with Cable 2 attached to Connector 1 on the end-panel of the Terrameter, and Cable 3 in Connector 2.

Note! Connector 1 is the *lower* of the two spread cable connections on the end panel of the Terrameter LS 2 and Connector 2 is the *upper* unit. This makes it easier to tighten the connector for the second half of the spread, once the first connector has been attached.

6.5.5 Roll-along and Specialist Station Types / Layouts

Once data collection is complete in the initial spread location, it is possible to extend the length of a survey profile by undertaking one or more roll-along manoeuvres. This is the process of moving one cable to the opposite end of the profile, moving the instrument along one cable so that it is, once again, in the middle of the spread, and creating a new station to register the new position. The instrument only collects datapoints made available by the new cable position, it does not repeat any of the previous data points within the overlap zone (see Figure 55, A). This process can be done with any cable spread, and normally one cable is moved at a time. There are stations in the “Create New Station” dialog designed to make the creation of roll-along stations quicker, by automatically entering the correct new position. The default variant is “1 Cable Forward”, which assumes the cable furthest to the left of the instrument will be moved to the right-hand end of the spread, and thus station co-ordinates will increase. There will normally be an option to roll-along in the opposite direction, named “1 Cable Backward”.

The 4x21 (81 electrodes) configuration is ABEM’s “extended” cable set, used to create a longer spread (and therefore deeper measurements) without adding any additional switching. For a given electrode spacing it improves the maximum theoretical depth by ~25% compared to a regular 64-electrode layout.

To achieve this, only the odd-numbered take-outs on Cable 1 and Cable 4 are connected to the switch matrix, which has a maximum capacity for 64 active electrodes. For the deepest measurements, the natural loss of resolution with depth means that the missing connections do not compromise the final dataset. However, for the near-surface measurements, it is necessary to use the minimum electrode spacing along the whole profile. For that reason, the first and last stations of a 4x21 profile are specifically designed so that an inner cable (Cable 2

or Cable 3) is used at the very start and end of the survey line, as these cables have all electrodes active.

When finishing a survey profile, with no additional cable and electrodes laid out, the instrument should still be moved one step forward in order to get all the near surface information. The active electrode cables will effectively be Cable 2 and Cable 3 (see Figure 55, B) and because it is only filling in some near-surface data points, only a small number of measurements need to be taken.

Although it looks cumbersome, the process of starting with only three cables, and finishing with two, allows the field crew to overlap lay-out and recovery of equipment with data collection; i.e. no need to lay everything out first and then stand idle waiting for data collection to complete. More details on the 4x21 procedure are in Appendix B. Survey procedure for common cable sets.

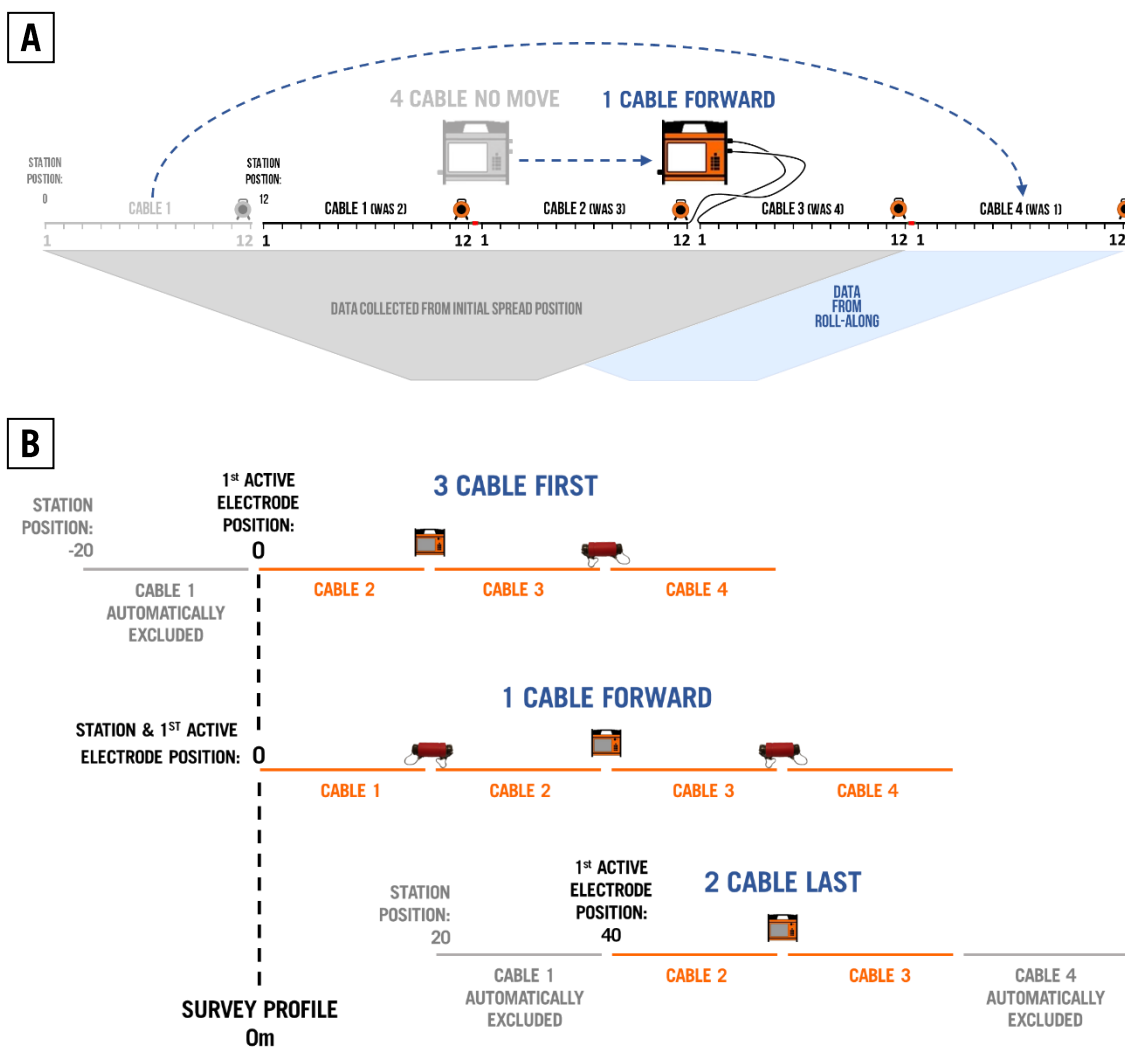

Figure 55 A: Roll-along procedure on a 4-cable, 12 take-out cable set with predefined station names from the Create New Task dialog written across the top; greyed-out features represent elements from the initial spread position.

B: General survey procedure for full data coverage using 4 x 21 take-out cables; to add more roll-alongs, just repeat the middle "1 Cable Forward" stage which automatically fills in near-surface data when Cable 4 becomes Cable 3 during the

rolling process. Once all roll-alongs are complete, finish by moving the instrument between the last two cables and selecting the “2 Cable Last” station.

6.6 3D Imaging Via Several 2D Layouts (2.5D Survey)

A simple way of carrying out a 3D survey is to measure a number of parallel (and, optionally, orthogonal) 2D profiles which are then merged into a single 3D dataset before inverting that file in a 3D inversion package. This method is often referred to as 2.5D survey and is probably the most common means of generating 3D datasets as it requires far less hardware and can be achieved with regular measurement protocols. In many cases the improvement in data quality and model accuracy provided by ‘true’ 3D survey does not warrant the additional cost and effort associated with large 3D layouts.

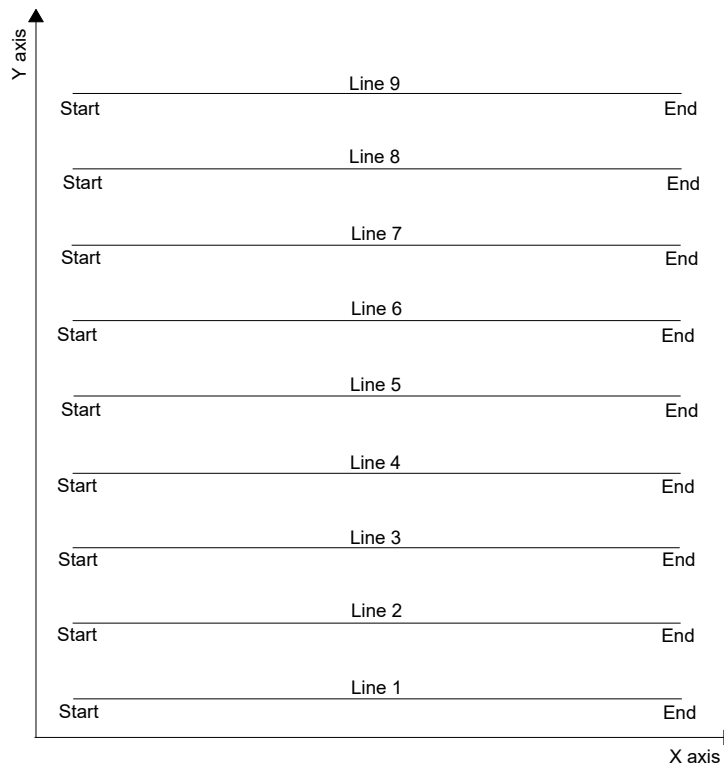

Figure 56 *This example shows a survey consisting of 9 parallel lines oriented in the x-direction and offset in the y-direction.*

A condensed step-by-step description is given below, in which it is assumed that the direction of the (first) electrode cable is called X, and that the perpendicular direction is called Y (Figure 56). In this figure, all lines have their first electrode at the same X location (no left-right offset) and it is only the Y location that differs between them. The description assumes that Res3Dinv (from Geotomo/Aarhus Geosoftware/Seequent) is to be used for the inversion, but the majority of the procedure should be applicable to alternative inversion software.

1. Decide on a layout i.e. the number of parallel profiles and, if required, cross-lines.
2. Decide which electrode configuration to use. As a general array, Multiple Gradient is a good choice but, if vertical structures are likely, Dipole-Dipole might be better.
3. On the Terrameter LS 2, select a suitable spread and protocol in accordance with points 1 & 2.

4. Roll out the electrode cables along the first survey line and connect the electrodes. Connect the electrode cables to the Terrameter LS 2 and start measuring in the new task; carry out any roll-along moves as necessary.
5. Whilst measuring on one line, preparations can be made for the next investigation line. **Ideally, the distance between lines should not exceed twice the electrode separation.** Using a separation between lines that is equal to the electrode separation will increase resolution. If extra resolution is required, the process can be repeated with the electrode cables rolled out in the perpendicular direction (Y-direction).
6. When measuring is finished on the first line, disconnect cables and electrodes and move to the second line. Start a new task and proceed with measuring as above. Note that station position values should only be entered for the X coordinate. Leave Y and Z to zero, the Y-offset will be handled in post-processing (collation).
7. Continue the measuring process on successive X-lines as far as desired; then complete any additional cross-lines.
8. After data acquisition is completed, download all the data files to a computer via Terrameter LS Toolbox, filter the results and export in the DAT-format used by Res2Dinv.
9. Make a copy of the file "COLLATE_2D_TO_3D.TXT" (used to list and arrange a set of 2D profiles for collation into a single 3D file). The original can be found in the Res2Dinv program directory and, in your new copy, change the filenames (for input and output) and the coordinates, according to the present survey. The line direction in Figure 56 is zero in all cases (Res2Dinv defines X as 0, and Y as 1) and the line direction/sign is also zero (Res2Dinv defines forward (i.e. L-R) as 0, and reverse (i.e. R-L) as 1).
10. Open Res2Dinv and use the option *File > Collate data into Res3dinv format* to merge the files. Progress will be reported onscreen.
11. Start Res3dinv and run an inversion on the newly merged data file.

6.7 3D Imaging by Electrode Grid Layouts

In some cases, over particularly complex targets or where a more precise model is required, the 2.5D procedure described above is not sufficient for 3D surveys. In such cases, a grid of electrodes can be used to generate a 'true' 3D dataset where measurements can be taken in all directions across the grid, as opposed to being taken along a single axis, as is the case with the 2.5D method.

Since the built-in relay matrix of a single Terrameter LS 2 can switch 64 electrodes, the maximum layout size would be an 8 x 8 grid of electrodes. For 'true' 3D surveys, it is often necessary to have larger electrode layouts and so one or more external electrode selectors (ES10-64C) must be connected to the Terrameter LS 2.

Typically, all true 3D surveys will use a custom spread and protocol depending upon the user's requirements for layout and electrode configuration (See Appendix C. *Spread and Measuring Sequence Files* for more information on spread and protocol files).

Sometimes with 3D measurements it is necessary to employ pole-dipole or pole-pole configurations, as these have much better ratios of measurement depth compared to spread width. The downside is that they require one or two remote electrodes connected individually

to the end-panel, and these must be positioned at a great distance from the main grid of electrodes (~10 – 20 times the grid width).

6.8 Marine Imaging Survey

It is possible to undertake resistivity surveys in, or on, water to map the geology beneath. Examples include: surveying on a river to determine bedrock depth for planning bridge foundations; mapping sediment depth in reservoirs; shallow near-shore geological studies. Survey can be undertaken in fresh or saline water, but conductive waters will severely limit the ability to penetrate the more resistive geological deposits beneath.

Marine surveys do not use electrodes but, instead, just allow current to flow from the cable take-outs into the water and material beneath. Marine surveys normally require special cabling depending upon the use case:

- **Standard cables:** shallow water, short-term immersion, occasional use, wire-wound stainless-steel take-outs.
- **Dual-purpose cables:** up to 40m water depth, prolonged immersion, regular use, enlarged solid stainless-steel take-outs, improved waterproofing.
- **Full marine cables:** depths greater than 40m, prolonged immersion, rough beds, regular use, further enlarged solid stainless-steel take-outs, manufactured with internal water-blocking compound and high-rated stress member

Dual-purpose cables are light enough to also use on land whereas the full-marine cables are typically too heavy and cumbersome to use out of water. Normally, all take-outs are mounted on a single cable length; this may require a split connector at one end to attach to the two instrument connectors (the other end of the cable is usually sealed).

Survey can be undertaken with the cables floated at the surface or sunk to the bed (or close to it). Floating the cables makes deployment and processing more straightforward as the inversion 'sees' the water column as just another layer; however, there is a significant power-loss within the water column. Sunk cables provide the best penetration of the sub-floor material but require additional information on water depth and water resistivity to be able to model the current patterns in the water column *above* the imaging cable. Regular 'dry land' spreads and protocols are suitable for static marine measurements (i.e. where the cable position is fixed during data collection, then moved to the next location and kept static again through the second phase of collection).

6.9 Cross-Borehole Tomography

Borehole measurements have some pre-requisites associated with them:

- The boreholes cannot be dry; fluid is required to be able to transmit current from the cable take-outs into the surrounding material.
- It is important to determine whether the boreholes are lined and, if so, with what. Metal casings are problematic as the current will only flow in the metalwork, whilst solid plastic casings will form an impenetrable insulating barrier to the current.
- Borehole tomography will require specialist electrode cables rather than the standard imaging cables used for surface measurement. These cables have longer lead-ins, are sealed at the far end (sometimes with a connection eye for adding weights), enlarged solid stainless-steel take-outs, better waterproofing and, if required, a strengthening member within the cable core.

Borehole tomography can be achieved using only down-hole take-outs or, alternatively, combined with surface electrodes to provide additional data points for the inversion software

to work with. Either way, custom spread and protocol files must be designed to suit the particular hardware configuration in use. See Appendix C. *Spread and Measuring Sequence Files* for more information on spread and protocol files.

6.10 Performing Data Acquisition

Data acquisition is controlled within the “Measure” Menu Item, under which there are nine Pages: “Progress”, “Resistivity Results”, “Pseudosection”, “Electrodes”, “Electrode Positions”, “VES Table”, “VES Curve”, “Borehole Log Curve”, and “Borehole Log”.

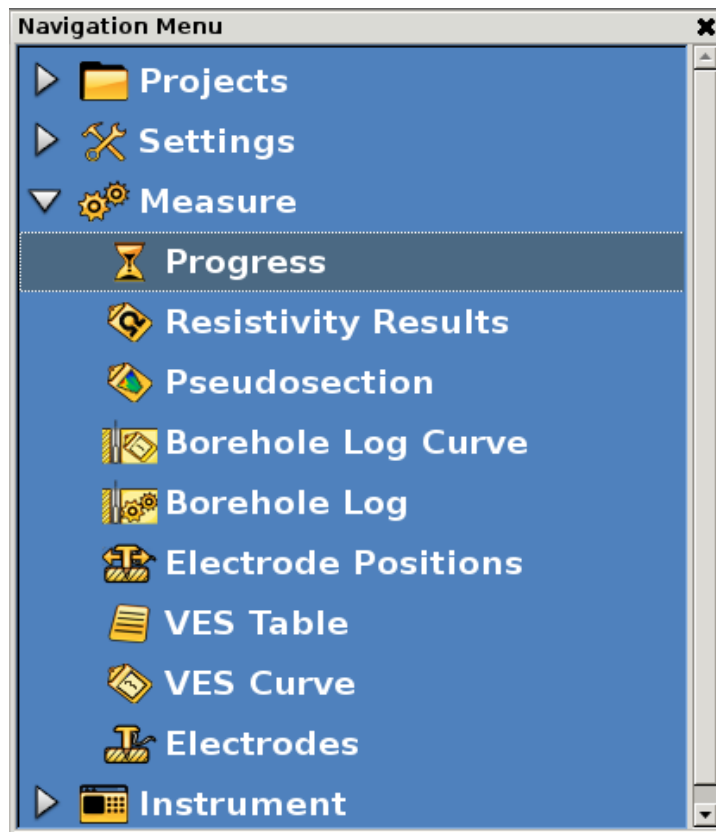

Figure 57 Navigation menu with Measure Menu Item and Progress Sub-item marked

6.10.1 Starting the Measurement

- Starting a measurement

- Navigate to the “Measure/Progress” Page
- If top row says < EMERGENCY STOP >, turn the safety switch to release it
- Move the highlight to the <Start Measuring> row (Figure 58)
- Press <OK>

Note! If <Start Measuring> is not shown, the station position has not yet been defined. Select <Create New Station (Roll Along)> to register the station position.

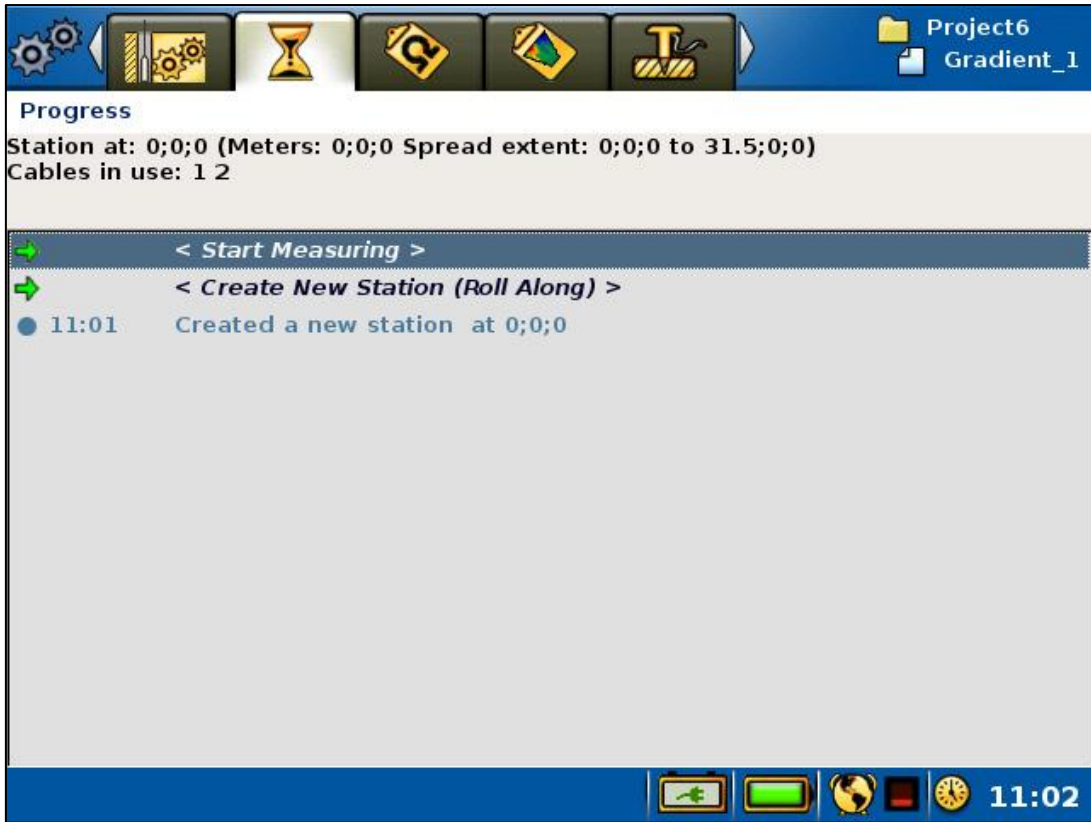

Figure 58 Start Measuring command on measuring progress Page

If the measurement setup involves transmitting current, that is if the measurement mode includes resistivity or IP, a warning message is issued (Figure 59).

Warning! Read the warning text (Figure 59) carefully before accepting to start the measuring process, and carry out the data acquisition accordingly!

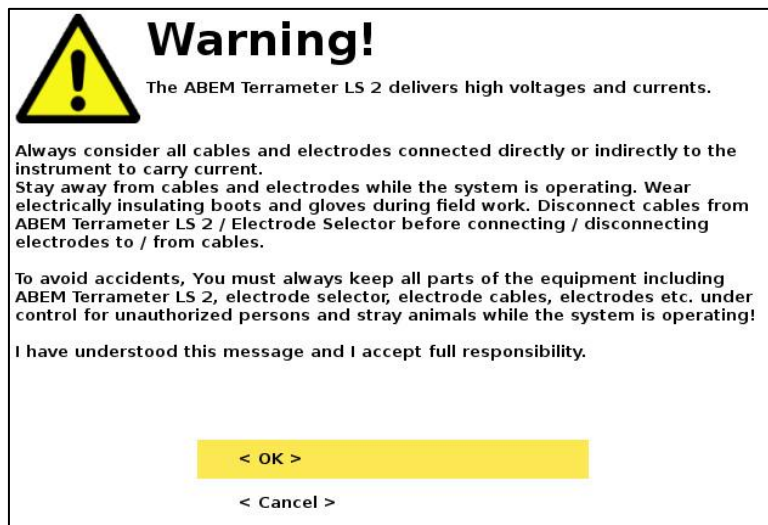

Figure 59 Electric shock warning dialog

6.10.2 Electrode Contact Test

The first step of the data acquisition phase is the electrode contact test. Using the ‘focus one’ method, each electrode is tested in turn. Only the electrodes required for the next phase of measurement are tested, so the number of electrodes under test may be fewer than the total number of electrodes in the spread.

If all electrodes are properly connected, well-grounded and the contact resistance is low compared to the selected thresholds and current, they will pass. The measuring process will commence immediately after the electrode contact test has finished in this case.

If any electrode registers poor contact, this will be reported in the progress list and the software will stop and wait for instruction from the operator. Navigate to the “Measure/Electrode” Page (Figure 60) to see the detailed results.

S	Takeout	Pos	Ohm	Status
		0;0;0		
1				
1-1		0;0;0	134Ω Ok	(AB:6)
1-2		0.5;0;0	130Ω Ok	(AB:6 MN:1)
1-3		1;0;0	130Ω Ok	(AB:6 MN:4)
1-4		1.5;0;0	145Ω Ok	(AB:6 MN:7)
1-5		2;0;0	164Ω Ok	(AB:6 MN:12)
1-6		2.5;0;0	130Ω Ok	(AB:6 MN:15)
1-7		3;0;0	135Ω Ok	(AB:6 MN:22)
1-8		3.5;0;0	130Ω Ok	(AB:6 MN:24)
1-9		4;0;0	144Ω Ok	(AB:6 MN:29)
1-10		4.5;0;0	168Ω Ok	(AB:7 MN:31)
1-11		5;0;0	138Ω Ok	(AB:6 MN:35)
1-12		5.5;0;0	138Ω Ok	(AB:6 MN:35)
1-13		6;0;0	136Ω Ok	(AB:6 MN:43)
1-14		6.5;0;0	146Ω Ok	(AB:6 MN:43)
1-15		7;0;0	130Ω Ok	(AB:6 MN:45)

Figure 60 Electrode contact status Page

Note any electrodes that have “Bad”, “Fail” or “No Contact” flags in the “Ohm” column.

Warning! Always push the emergency stop button prior to handling electrodes

Locate the problem electrodes and, first, check jumper wires are firmly connected to the electrode and take-out. Next, ensure that electrodes are well grounded (hammer deeper, reposition slightly, add water, double-up electrodes etc.) then release the stop button and restart measurements. This will automatically retest all the “Bad”, “Fail”, or “No Contact” electrodes; it will NOT retest electrodes that have already passed. After retesting, the instrument will either begin the survey or produce another failed message. In case of another fail, repeat the process of locating poor electrodes and attempting to improve their grounding. Retest the electrodes after each improvement. Repeat the process, until the electrode contact test passes.

It is advisable to start with a low test-threshold (i.e. 1000 Ω) because if all electrodes pass, good contact should be guaranteed. However, if most electrodes are “Bad”, but have similar contact resistance values, this would indicate that the ground is generally more resistive; consider increasing the threshold, restarting the measurement and looking for the outliers in the new contact test results.

In some cases, it may be necessary to exclude or ‘force use’ individual electrodes. This can be done via the pop-up menu (accessed by pressing the OPT key) either manually or by choosing an automatic option, for example excluding all “Bad” electrodes. It is also possible to exclude a whole cable through the pop-up menu. Any excluded electrodes will have an “X” next to them in the first column; those which are forced to be used despite failing the electrode test will have a “U” next to them. When excluding electrodes, use the “Status” column to see the impact it will have on the final dataset; the “AB” count is how many times that electrode will be used for current injection, “MN” is how many times it will measure voltage.

6.10.3 Progress Information

The measuring progress is shown on the “Measure/Progress” Page (Figure 61).



Figure 61 Progress Page

The top of the “Measure/Progress” Page shows the location and extent of the cable spread (in relative electrode position and absolute distance), and which of the cables are still active. The “Cables in use” flags update in real-time and indicate which cables are required to collect the remaining data points at the present measurement station. Once a cable disappears from this list, it can be moved or packed away.

Warning! Always push the emergency stop button prior to handling cables.

The left part of the *Status Bar* across the bottom of the screen shows the progress in terms of how many measurements have been written to disk compared to the total number of measurements that needed collecting since the last measurement start.

When all available data points have been collected from a given station position, the *Status Bar* will show “Measuring done!” and the <Stop Measuring> row will be replaced with the “No data points to measure” notification (Figure 62).



Figure 62 Measurement ready example

All significant events that occur during the measurement process are listed in the log on the “*Measure/Progress*” page. It is important to check the different parts of the *Progress Page* during the measurement. The logged events are also saved in the project database, readable in Terrameter LS Toolbox and are exported as a part of the TXT file format (see Chapter 7.2.2 *Export a Task as a TXT (Text) File*).

One type of event that can occur and be recorded in this log is a measurement error. These events would normally trigger a *Measuring Error* dialog during data collection. For more information about this error handling see Chapter 6.13 *Measurement Errors*.

6.10.4 Data Viewing Options

The data can be viewed and analysed during data collection in more than one format. The most diagnostic and useful for in-measurement quality control is the tabled results shown on the “*Measure/Resistivity Results*” Page (Figure 63). As this tab is adjacent to the “*Measure/Progress*” Page, it is easy to switch back and fore between the two during measurement using the <Browse> and <Shift>+<Browse> key combinations.

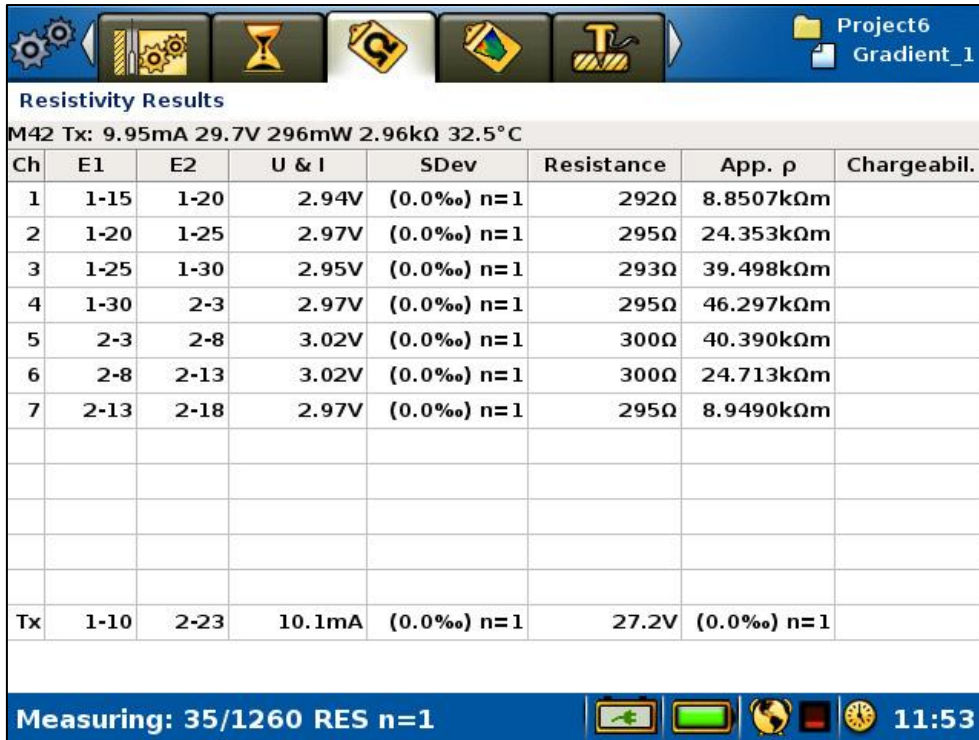

Figure 63 Resistivity results Page

The measurement number (“M42”) and key values for the transmitted signal are displayed in the header, immediately below the *Page* title. These are the transmitter set-up values for this measurement, determined by a short test injection made at the very start of the measurement cycle and limited by the user-defined transmitter settings.

Note! The measurement number does not reset when creating a new *Task* or switching between *Tasks*, it is incremented continuously within a *Project*.

One measurement cycle can present results from anything between one and twelve of the input channels, plus the transmitter-monitoring channel (Tx). The actual number of measurements depends on the number of active input channels on the instrument license, the hardware layout, and which electrode configurations are used in the protocol.

The input channel data includes, from left to right: channel number, electrode locations for the voltage pair (cable no. – electrode no.), measured voltage, normalized standard deviation (variation coefficient), resistance, apparent resistivity, and, if applicable, chargeability. Note that the normalized standard deviation can be shown in percent (%) or permille (‰).

The transmitter channel, Tx (bottom row), represents the final measured output current and output voltage, which may be slightly different from the predicted values returned by the short set-up test. This is especially true of the voltage which varies to maintain a constant current during measurement. The table shows, from left to right: Tx channel, electrode locations for the current pair, output current, normalized standard deviation for the current, output voltage, and normalized standard deviation for the voltage. Again, the normalized standard deviation can be presented in percent (%) or permille (‰).

An alternative data view available on the instrument is the pseudosection, as can be seen on the “*Measure/Pseudosection*” *Page* (Figure 64).

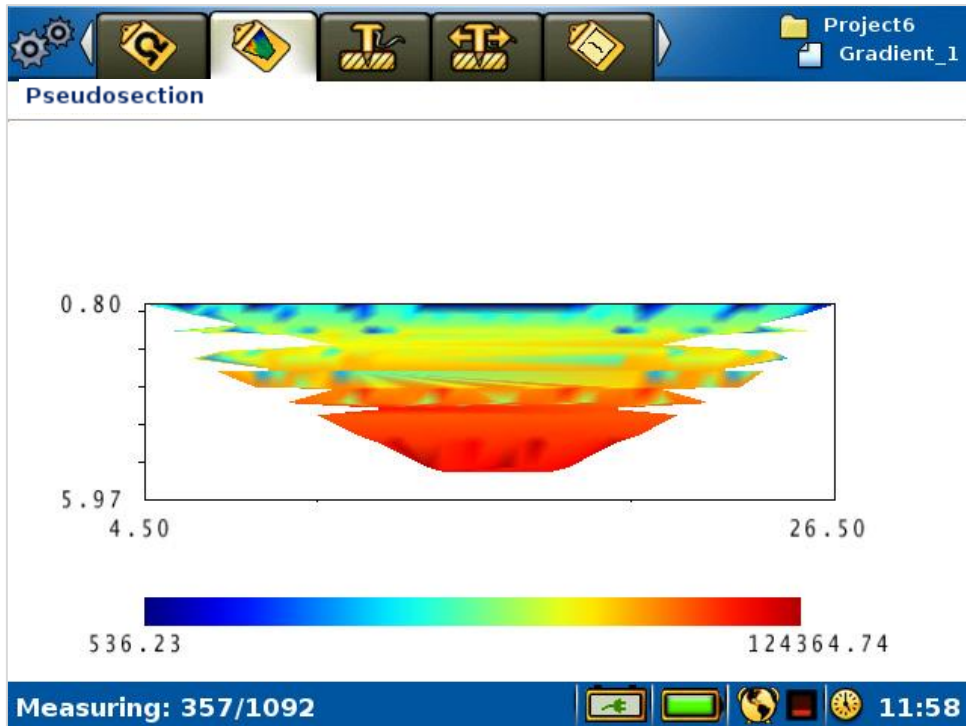

Figure 64 Pseudosection Page

6.10.5 Pausing and Stopping the Data Acquisition

- Pausing or stopping the measurement

- Move the highlight to the <Stop Measuring> row (Figure 61)
 - Press <OK>
- Or
- Press <Play-Pause>

The pause function waits for the active measurement cycle to complete before activating. As such, it might take a few seconds before the measuring pause dialog is shown (Figure 65). From this dialog it is possible to resume or stop the data acquisition process.

- Move the highlight to the appropriate row
- Press <OK>

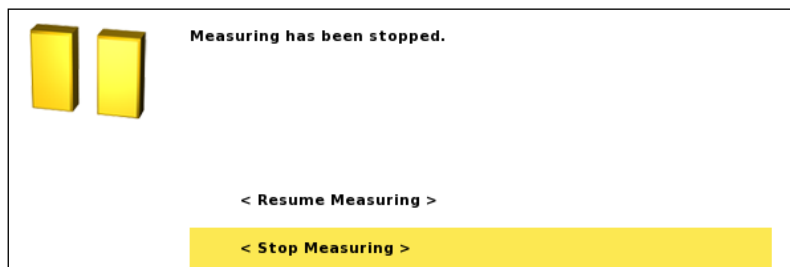

Figure 65 Measuring pause dialog

The Stop button on the Terrameter LS 2 end panel will provide a faster stop of activity. No dialog is shown when stopping in this way. To resume, release the Stop button and press

<Play-Pause> or move to the “Measure/Progress” Page and select <Start Measuring>.

6.10.6 Deleting, Undeleting and Re-measuring Data

If a problem with data acquisition is detected, the measurement process can be stopped and data deleted back to a user-defined point, allowing data points to be re-measured.

- Deleting data

- Stop an ongoing measurement (6.10.5 Pausing and Stopping the Data Acquisition)
- Highlight the row in the progress list corresponding to the point from which data should be re-measured
- Press <Options>
- Highlight “<Delete measurements after Mxxxx>” (where Mxxxx represents a measurement ID) (Figure 66)
- Press <OK>

< Delete measurements after M2071 >

Figure 66 Delete data points option menu

This action will delete data points and create a new entry in the progress list, “Deleted ‘Measurement Mxxx,...,Mxxx n=xxx’” (Figure 67). The “Mxxx” section shows the span of measurement IDs that were deleted and the “n” value is the number of data points deleted (remember that a single measurement ID can have up to 12 data points associated with it).



Figure 67 Example of deleted data points

- Undeleting data

- Stop an ongoing measurement (6.10.5 *Pausing and Stopping the Data Acquisition*)
- Highlight the “Deleted ‘Measurements...’” row in the progress list that represents the point from which data should be undeleted
- Press <Options>
- Highlight “<Undelete ‘Measurements Mxxx,...,Mxxx n=xxx’>” (Mxxxx represents a measurement id) (Figure 68)
- Press <OK>

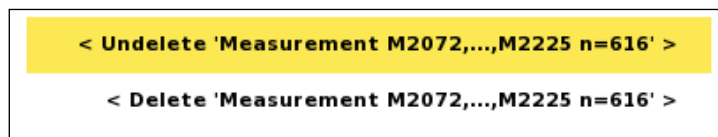

Figure 68 Undelete/Delete data points Option menu

The command will also create a new entry, this time called “Undeleted ‘Measurement Mxxx,...,Mxxx n=xxx’”, with the same numbers as the deleted entry (Figure 69).



Figure 69 Example of undeleted data points

If data points are to be deleted at the end of a measurement (with the “Measure/Progress” Page showing “No datapoints to measure”), measurements can be started again when some data entries have been deleted.

6.11 Vertical Electrical Sounding

Vertical Electrical Sounding, VES, can be carried out using a set of standard VES cables and by manually moving four electrodes. The four electrodes connect, via cables, to the C1, C2, P1 and P2 connectors on the LS 2 end-panel. The “Measure/Electrodes” Page for a VES Task will consequently look similar to the one shown in Figure 70.

The LS instrument is said to be in VES mode when the active Task is a VES Task, that is the Task was created with a VES protocol.

S	Takeout	Pos	Ohm	Status
		0;0;0		
LS Panel				
	C1	2;0;0	(0)	(AB:1)
	C2	-2;0;0	(0)	(AB:1)
	P1	0.1;0;0	(0)	(MN:1)
	P2	-0.1;0;0	(0)	(MN:1)

Figure 70 The Electrodes Page in VES mode

The electrode positions are pre-defined in a measurement protocol and thus the electrode coordinates will automatically be saved together with the measured data. The measurement protocols must be written in a special format (see Appendix C. Spread and Measuring Sequence Files, 11.4 Protocol Files in XML-format for VES).

In VES mode there will be primarily four Pages involved:

- The “Measure/Progress” Page (Figure 72) will be used to start and stop measurements as usual. Choosing which of the predefined electrode positions to measure from can also be set from this Page.
- The “Measure/Electrode Positions” Page (Figure 73) displays a list of all the possible electrode positions that are predefined in the active Task. The electrode positions can be set manually (and a new temporary electrode position created) from this Page.
- The “Measure/VES Curve” Page (Figure 79) displays a sounding curve of the measurements made so far in the active task.
- The “Measure/VES Table” Page (Figure 80) displays a reviewable table of the measurements made so far in the active task.

6.11.1 Managing Electrode Positions

Electrode positions for a VES *Task* are handled differently depending on the array type. Most common is the Schlumberger array and, for this electrode arrangement, positions are given as “MN/2” and “AB/2” distances, where MN is the distance between P1 and P2, and AB is the distance between C1 and C2). These are entered into a VES protocol file as absolute distances and no multiplier is required, which is why all three coordinates (X, Y and Z) are greyed-out in the “Create New Task” dialog for VES.

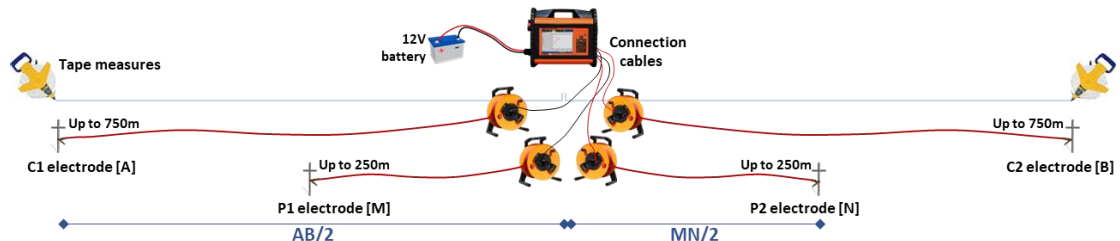

Figure 71 Schematic of a VES (Schlumberger) layout

In VES mode, with a Schlumberger protocol selected, a line with a “MN/2 and AB/2” electrode position will be shown on the *Progress Page* (Figure 72). This is the active electrode position, and it can be changed using the left and right arrows. It is thus possible to step through all available electrode positions that are pre-defined in the protocol file; measurements do not necessarily need to be undertaken at every interval.

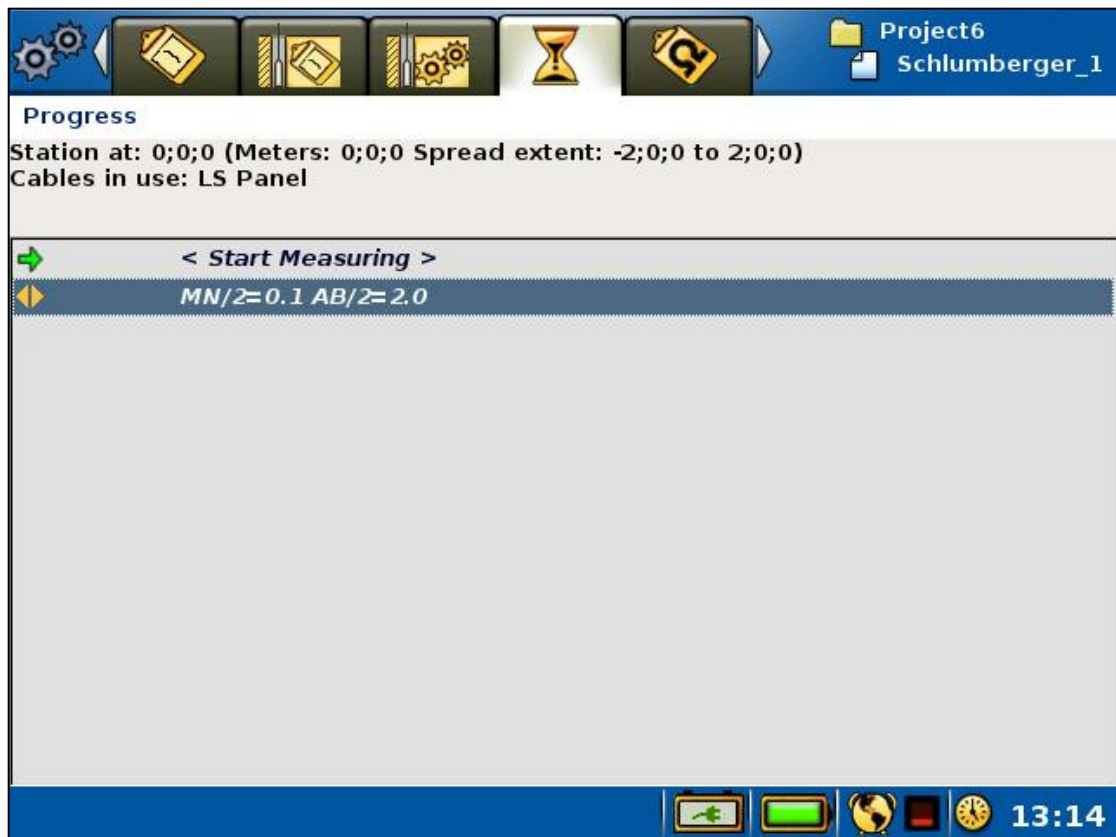

Figure 72 The Progress Page in VES mode

- Changing the active electrode position from the *Progress Page*

- Highlight the “MN/2= x AB/2= x” row in the progress list
- Press <Left> and/or <Right>

It is possible to create new, custom, electrode positions in the “Measure/*Electrode Positions*” *Page* (see below) which then become part of the predefined list. They can then be selected as the active electrode position in the same way as the predefined electrode positions, by using the left and right arrow keys.

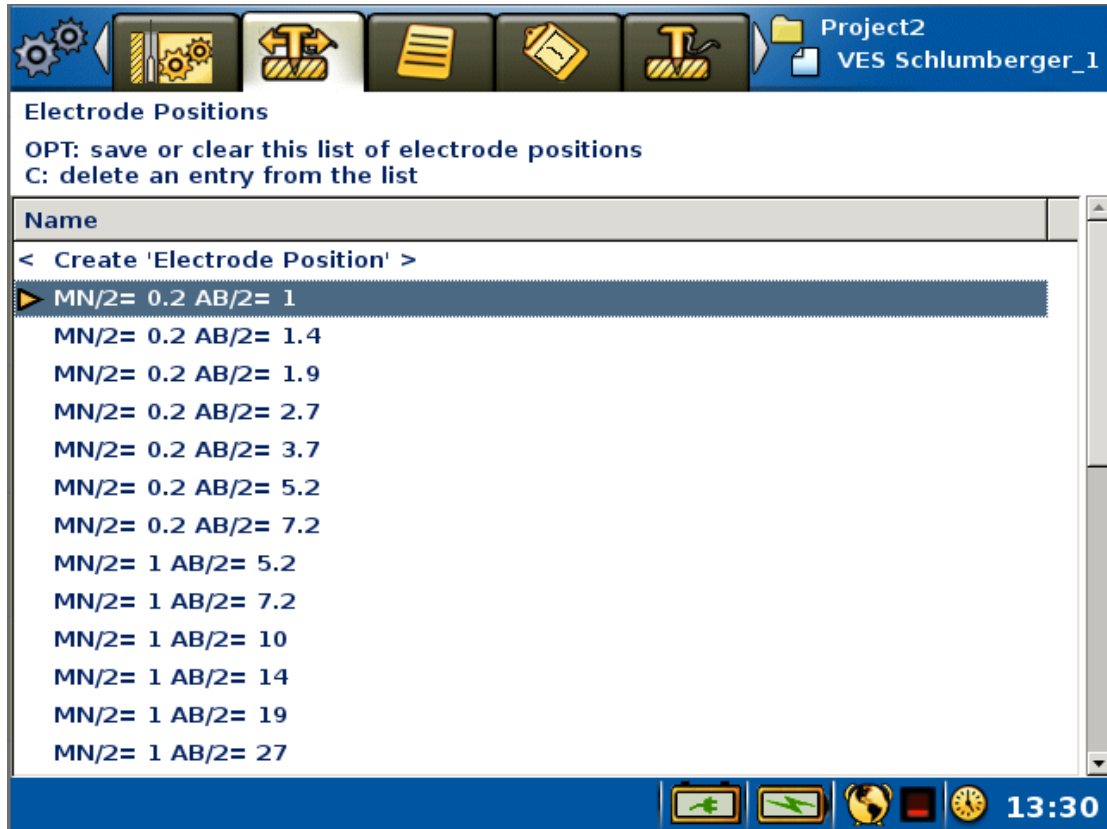

Figure 73 *Electrode Positions Page in VES mode. Highlight bar (blue) and active electrode position marker (yellow) both on the second row*

The *Electrode Positions Page* (Figure 73) lists all the electrode positions from the protocol file. The yellow arrow is placed on the line that corresponds to the active electrode position. This electrode position is the one that is shown on the second row of the *Progress Page* (Figure 72). The *Electrode Positions Page* will be empty when the instrument is not in VES mode.

- Changing the active electrode position from the *Electrode Positions Page*

- Highlight the required electrode position in the list
- Press <OK>

A new, custom, electrode position can be created for use during the measurement session.

Note! Custom electrode positions are not saved to the list by default and will be lost at power-off or if the active *Project* or *Task* is changed. To retain them use the save option or create a custom VES protocol file for upload to the instrument.

- Creating a new electrode position

- Navigate to the “Measure/Electrode Positions” Page (Figure 73)
- Highlight the first row <Create ‘Electrode Position’>
- Press <OK>, the Create Electrode Position dialog will be shown (Figure 74)
- Enter the positions for the current electrodes (A and B) and potential electrodes (M and N). The electrode positions are given as the distance from the mid-point of the electrode spread.
- Choose the correct settings (Yes or No) for “B Remote” and “N Remote” (used for pole-pole and pole-dipole surveys).

If “B Remote” or “N Remote” is set to “Yes” then any numbers specified for “B[m]” or “N[m]” will be ignored.

- Press <Down> to highlight the OK command and press <OK>

The new electrode position will be shown as first in the “Electrode Positions” list and will be made the active position automatically (Figure 75).

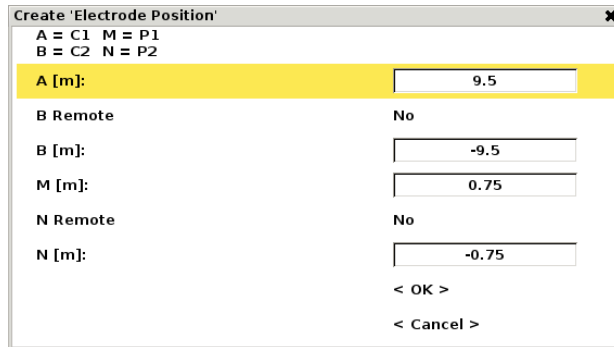

Figure 74 Create Electrode Position dialog

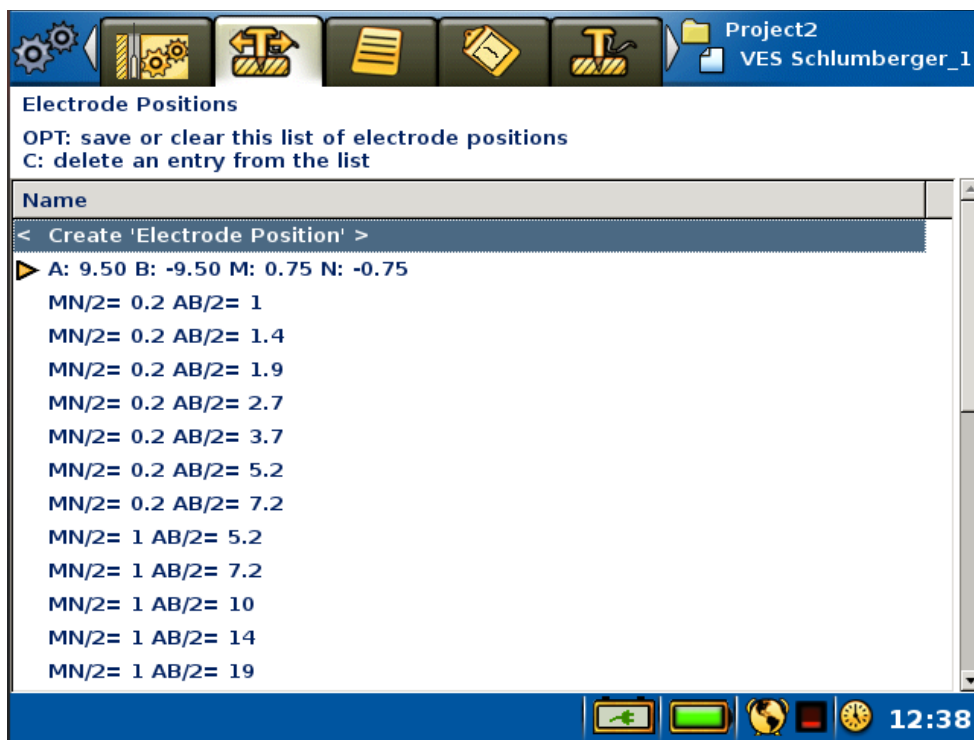

Figure 75 Result of using Create Electrode Position dialog

- Deleting an entry from the *Electrode Positions* list

- Highlight the required electrode position in the list
- Press <C> and confirm

- Deleting all entries or saving the *Electrode Positions* list as a new protocol

- Press <OPT> to bring up the *Save* dialog (Figure 76)
- Either
- Select < Clear list > and press <OK>
- Or
- Edit protocol name, as required
 - Select < Save > and press <OK>

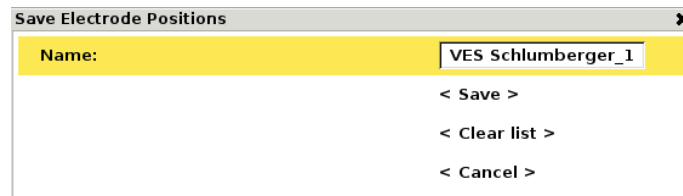

Figure 76 VES Electrode Positions save dialog

6.11.2 Performing a VES Measurement

- Starting a VES measurement

- Choose an electrode position using one of the methods described above
- Ensure that the electrodes have been moved to the correct physical position and check that field crew and other people are clear of the electrodes and cables
- If selecting the active electrode position was done from the *Electrode Positions Page*, navigate back to the *Progress Page*; the quickest way to do this is to press <Play/Pause>
- Highlight the < Start Measuring > command at the top of the progress list
- Press <OK>
- The pre-measurement safety warning will now be displayed and measurement will start once the content of that message is accepted

Warning! Do not press <OK> until it is verified that no person or animal is touching any part of the electrode cables, connectors or electrodes

Figure 77 shows the *Progress Page* during a VES measurement. The measurement can be paused, stopped and resumed as described in Chapter 6.10.5 *Pausing and Stopping the Data Acquisition*.

Note! If any person or animal approaches the electrode layout during measurement it is advisable to stop current transmission immediately with the red Stop button on the end panel of the instrument

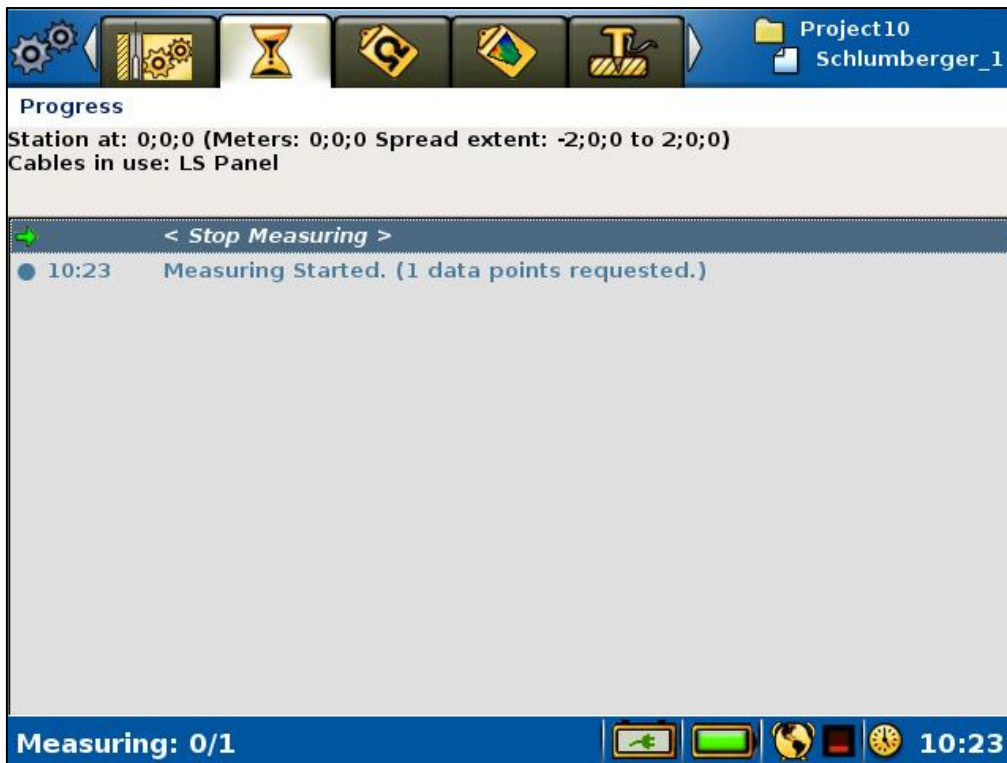

Figure 77 Progress Page in VES mode during on-going measuring

When the measurement is ready the *Status Bar* will show “Measuring done!” and the stop-measuring row will be replaced with a “No data points to measure” statement (Figure 78).



Figure 78 Part of the Progress Page in VES mode after measuring a data point

- Measuring the next data point

- Make sure the “MN/”= x AB/”= x” row is highlighted
- Press <Right>
- Press <Up>
- Press <OK>

6.11.3 VES Sounding Curve

In VES mode a sounding curve will be shown in a double logarithmic diagram on the *VES Curve Page* (Figure 79). Focus depth (median depth penetration) will be on the vertical axis and apparent resistivity on the horizontal axis. The marker for individual datapoints will change shape when the MN spacing changes.

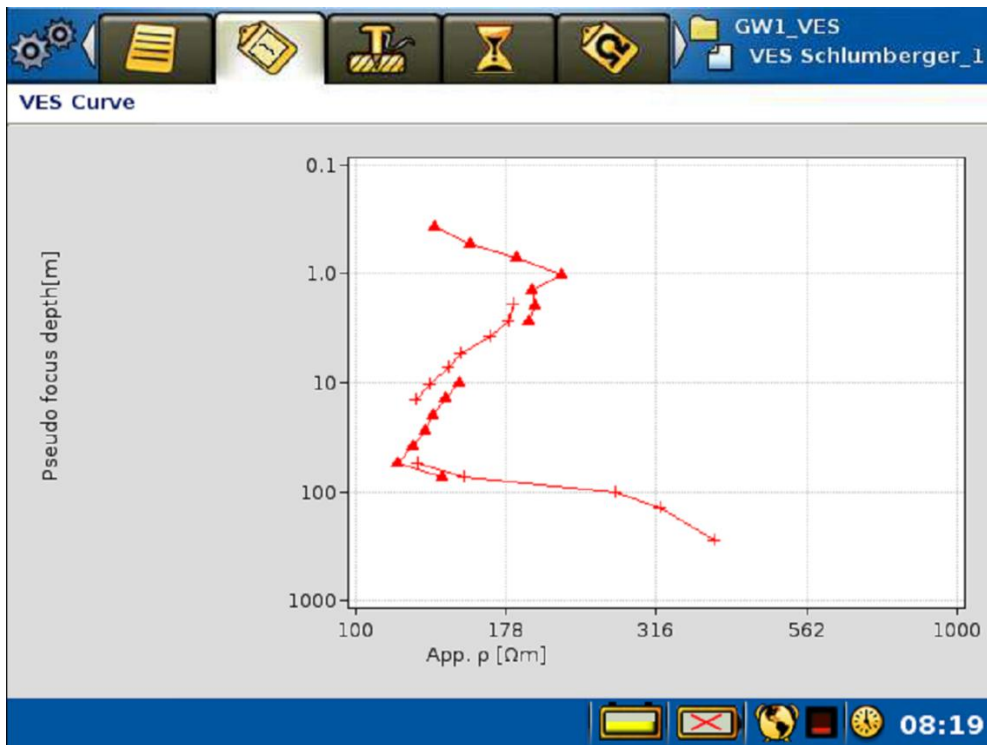

Figure 79 VES Curve Page example

6.11.4 VES Table

The VES Table lists all data points collected in the active *Task*, with the most recent measurement first. Using the <Up> / <Down> arrow keys will scroll through the results; the screen will automatically refresh with the next set of data values when you scroll past the bottom of the initial list.

The figure shows a VES Table page. The table has the following columns: ID, A, B, M, N, U, SDev, App ρ, and Chargeability. The data is as follows:

ID	A	B	M	N	U	SDev	App ρ	Chargeability
41	149.0	-149.0	5.2	-5.2	3.77mV	2.7%	122.41Ωm	0.3%
40	140.0	-140.0	5.2	-5.2	4.01mV	3.4%	117.39Ωm	0.8%
37	100.0	-100.0	5.2	-5.2	8.11mV	2.4%	124.72Ωm	0.9%
36	72.0	-72.0	5.2	-5.2	16.1mV	3%	130.49Ωm	0.7%
33	52.0	-52.0	5.2	-5.2	59.4mV	2%	134.79Ωm	1.1%
32	37.0	-37.0	5.2	-5.2	125mV	0.8%	141.09Ωm	1.3%
29	27.0	-27.0	5.2	-5.2	169mV	1%	149.35Ωm	1.6%
28	37.0	-37.0	1.0	-1.0	14.1mV	0.6%	126.22Ωm	1.9%
25	27.0	-27.0	1.0	-1.0	27.9mV	2%	133.20Ωm	1.5%
24	19.0	-19.0	1.0	-1.0	60.6mV	1%	143.11Ωm	1.0%
21	14.0	-14.0	1.0	-1.0	117mV	1%	149.79Ωm	1.5%
20	10.0	-10.0	1.0	-1.0	259mV	2%	168.05Ωm	1.7%
17	7.2	-7.2	1.0	-1.0	575mV	2%	191.55Ωm	1.3%
16	5.2	-5.2	1.0	-1.0	1.07V	2%	182.70Ωm	1.6%
13	7.2	-7.2	0.2	-0.2	120mV	2%	203.07Ωm	1.0%

The table is titled 'VES Table' and is part of a software interface with various icons and a status bar at the bottom showing the time 09:16.

Figure 80 VES Table Page example

6.12 Borehole Logging with the Terrameter Log 300

The Log 300 is a plug-and-play logging system for the whole Terrameter family of products. The Terrameter Log is intended for logging to a depth of 300 meters.

This simple logging accessory makes it possible to delineate formation boundaries, which can help inform upon differences in infiltration, porosity and permeability by means of self-potential and resistivity measurements. Under favourable circumstances, water flow boundaries can be detected by measuring temperature changes. Moreover, the resistivity of the water can be measured in situ so that an estimate of total dissolved solids (TDS) can be made. Zones of high salinity may be localized and sealed off by means of casing and cementing.

6.12.1 The Hardware



Figure 81 Terrameter Log 300 with backpacking frame

The Terrameter Log 300 (Figure 81) consists of a 300 m long downhole cable with a logging probe and a backpacking frame. Mounted on the frame is an electronic unit as well as connectors for the *Potential Reference / Current Return* and a connector for coupling to the Terrameter. The connectors are on the reverse of the backpacking frame (Figure 82).



Figure 82 Connectors on the reverse of the backpacking frame

The downhole cable has seven nylon-insulated conductors and a polyurethane jacket. A Kevlar stress member is incorporated, providing a 4000 Newton strain capacity. The cable is marked at 1 m intervals, starting at the logging probe shoulder. Three cylindrical take-outs are located 5.6 m, 1.2 m and 0.4 m up from the probe shoulder.

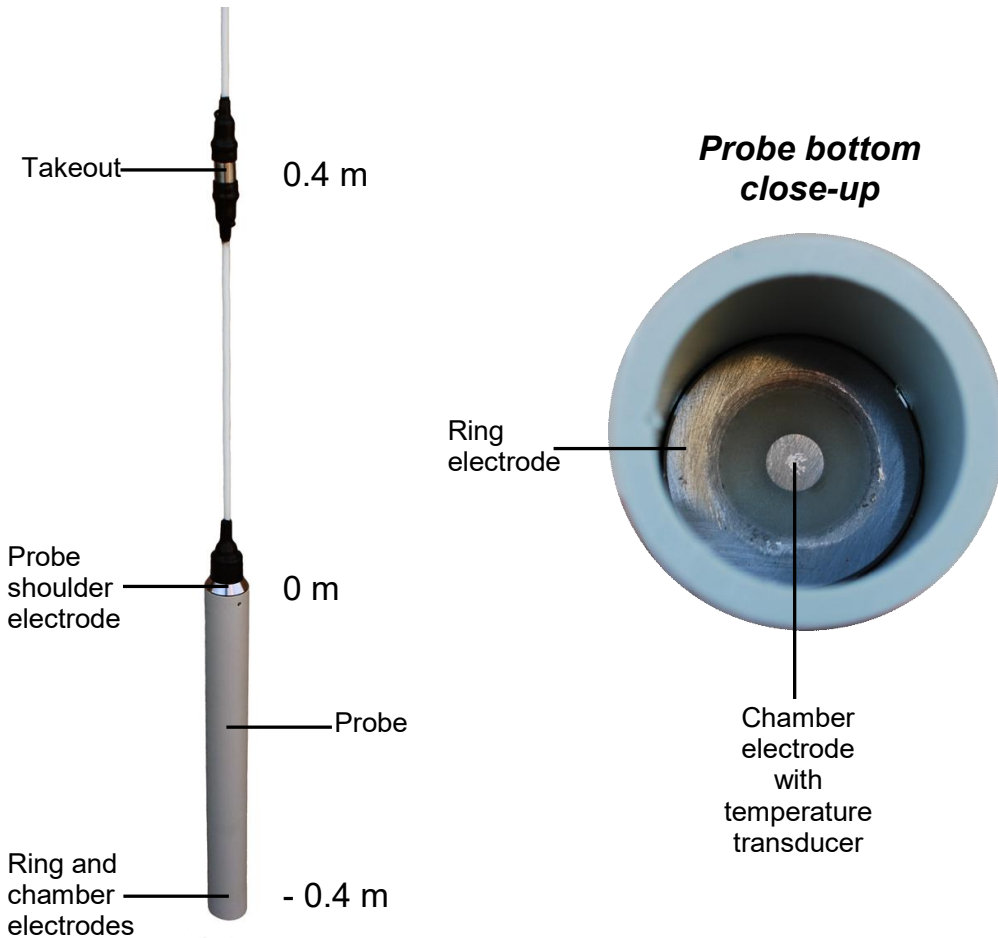

Figure 83 Logging probe with close-up of probe bottom

The stainless steel upper end (shoulder) of the logging probe serves as a 0 m electrode (Figure 83). The lower inside end of the probe - the chamber - has one ring electrode (the -0.4 m electrode) and one electrode in the centre (the chamber electrode). The centre electrode also contains the temperature transducer. The end of the chamber is set at an angle to improve fluid circulation in the chamber as the probe moves. Three holes in the chamber wall permit air to escape, thus ensuring good electrode contact with the fluid.

A multi-function cable (33 0020 11) connects the Terrameter Log 300 to the AUX port on the Terrameter instruments. The Terrameter LOG 300 is fully governed from the Terrameter.

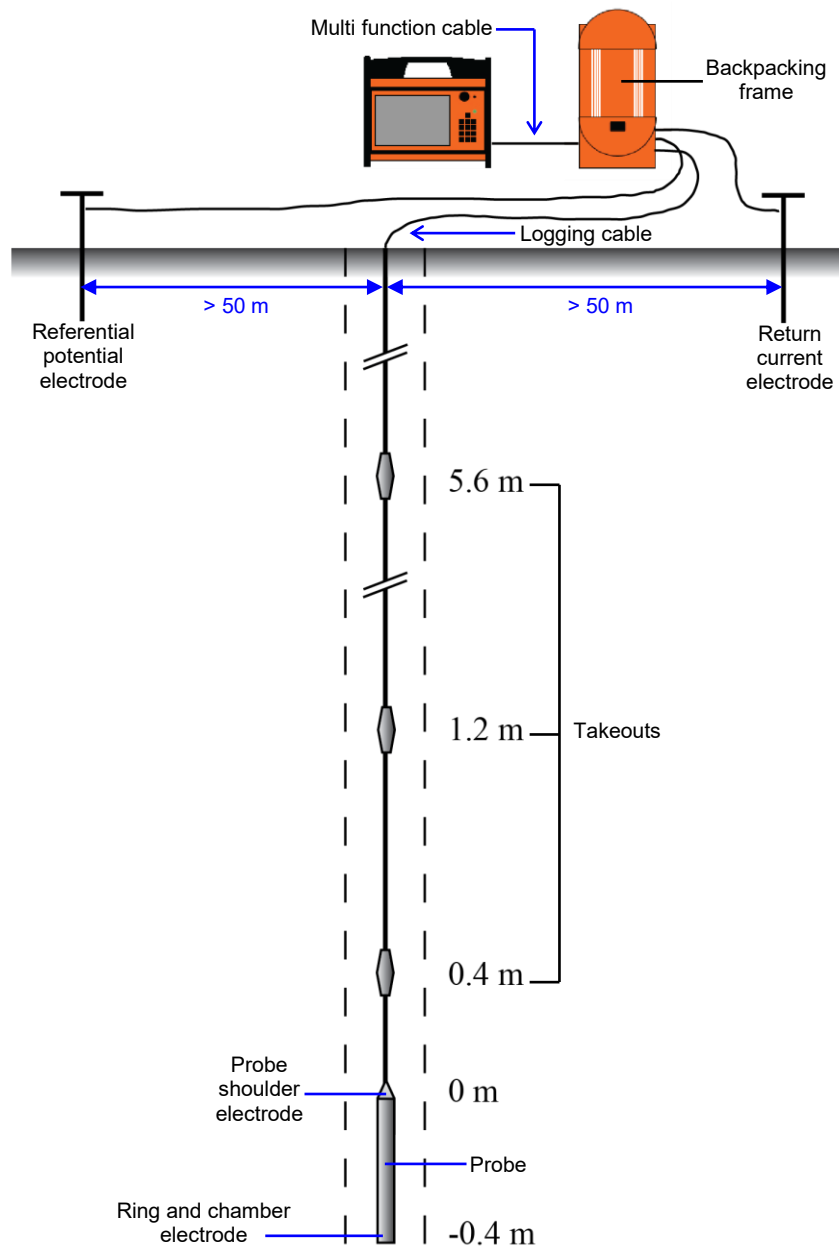

Figure 84 Overview of cabling and layout of the electrodes

The *Return Current* connector should be attached to a return current electrode (i.e. ABEM stainless steel electrode) placed no less than 50 m from the well to be surveyed.

The *Potential Reference* connector should be connected to a reference potential electrode (i.e. ABEM stainless steel electrode) not less than 50 m from the well and in the opposite direction to the return current electrode.

Note! Even though there is a test function for testing the ground connection of these remote electrodes, great care should be exercised when installing them to ensure reliable electrical connection with the ground.

Directly after power on, the Log 300 will perform a self-check, which takes a few seconds. During the self-check a few clicks will be heard from the electronic unit in the backpacking frame.

Note! During logging operation there should be no connections to C1-C2 and P1-P2 terminals on Terrameter LS 2.

6.12.2 Quick Look: A Normal Borehole Logging Session

A short introduction to a normal borehole logging session with references to the relevant Chapters:

1. Set up the hardware (see 6.12.1)
2. Do an electrode test (see 6.12.5.2)
3. Do a water level check (see 6.12.5.4)
4. Run a depolarization routine (see 6.12.5.3)
5. Set-up temperature and SP to be measured on the down-logging phase (see 5.2.2)
6. Set-up resistivity and IP to be measured on the up-logging phase (see 5.2.2)
7. Undertake down logging (temperature and SP recorded) (see 6.12.5.5)
8. Undertake up logging (resistivity and IP recorded) (see 6.12.5.5)
9. Save the recorded data as LAS and perform post-processing routines (see 6.12.6)

6.12.3 About Borehole Logging Measurement Modes

The Terrameter LS 2 uses the concept of “measurement modes” to facilitate different operations during a borehole logging session. Three different types of operation are covered:

- Preparation (electrode test, depolarize, level check)
- Down-and-up logging (down, up)
- Single value measurement, one for each measurement type (temperature, SP voltage, short normal, long normal, long lateral, fluid resistivity).

An overview of the measurement modes:

Down	Downward logging where values of up to six different measurement types are recorded for each step
Up	Upward logging where values of up to six different measurement types are recorded for each step
Electrode Test	Test of the remote C and P logging electrodes

Depolarize	Equalizes built-up transmitter potentials prior to SP measurements
Level Check	Find the water level
Temperature	Only temperature is measured for the current probe level
SP Voltage	Only SP voltage is measured for the current probe level
Short Normal (Res & IP)	Only short normal is measured for the current probe level
Long Normal (Res & IP)	Only long normal is measured for the current probe level
Long Lateral (Res & IP)	Only long lateral is measured for the current probe level
Fluid Resistivity	Only fluid resistivity is measured for the current probe level

6.12.4 About Borehole Logging Measurement Types

6.12.4.1 Temperature and SP Voltage

Normally, temperature and SP are logged on the first run down into the well, in the unstirred water and with no polarization effects residing from resistivity measurements.

When assuming high precision for temperature gradient studies, ample time must be allowed to permit the probe to reach thermal equilibrium with the surrounding fluid. Move the probe slightly up and down a few times while waiting for equilibrium to be established. Temperature logging should be the first log at each station, since undisturbed water is required.

To reduce electrode polarization, attributable to previous resistivity measurements or prolonged storage in air, the electrodes should be depolarized before SP logging starts.

Note! Resistivity or IP should not be measured during a SP logging run.

6.12.4.2 Short Normal

Current is injected via the shoulder electrode (0 m). The corresponding response voltage is measured between the ground potential reference and the ring electrode at the bottom of the probe. The Terrameter LS 2 will display the resistivity of the surrounding medium.

6.12.4.3 Long Normal

Current is injected via the 1.2 m takeout while the potential is measured at the ring electrode at the bottom of the probe. The Terrameter LS 2 will then display the resistivity of the surrounding medium.

6.12.4.4 Long Lateral

Current is injected via the 5.6 m takeout while the potential is measured between the ring electrode at the bottom of the probe and the 0.4 m takeout.

The Terrameter LS 2 will automatically perform the necessary conversions, and display the resistivity of the surrounding medium, measured with the "Long Lateral" configuration.

6.12.4.5 Fluid Resistivity

The current is injected via the ring electrode, while the potential is measured between the shoulder electrode (0 m) and the chamber electrode. The fluid resistivity is calculated, presented on the display, and saved in the Terrameter LS 2. In case of small-diameter wells a correction is needed. The table below lists the correction factors to be used. The calculation is done manually in post-processing.

Well diameter in mm.	Correction factor
50 - 60	1.08
60 - 70	1.06
80 - 90	1.03
90 - 100	1.01

6.12.4.6 Fluid resistivity and estimation of TDS

As the Terrameter Log 300 can be used to measure the resistivity of a fluid, this allows for an estimation of the Total Dissolved Solids (TDS) in the fluid. This is often used as a means of estimating water quality.

Resistivity is a function of water temperature, and a standard temperature (usually 25°C) must be specified for reporting the resistivity or conductivity. For resistivity, the approximate conversion formulas to obtain the resistivity at common standard temperatures are as follows:

$$\rho_{18} = \rho_T (0.62 + 0.021 T)$$

$$\rho_{20} = \rho_T (0.58 + 0.021 T)$$

$$\rho_{25} = \rho_T (0.48 + 0.021 T)$$

where T is the measured temperature of the fluid in °C (in the range 5 - 50 °C for the conversion to be valid) and ρ_T is the measured fluid resistivity at that temperature.

The concentration of ions commonly found in groundwater are often reported by weight in parts per million (ppm). One "ppm" defines one part, by weight, of the ion to a million parts, by weight, of water; it is numerically equivalent to milligrams per litre. TDS is also reported as ppm. The TDS for an average of natural groundwater samples is estimated as:

$$TDS_{ppm} = 6400/\rho_{25} \quad \text{where } \rho_{25} \text{ is in } \Omega\text{m at a standard temperature (25°C here)}$$

Conductance is sometimes preferred for the estimation of TDS (rather than resistance, its reciprocal) since it increases with salt content. Conductance is measured in Siemen (i.e. Ω^{-1} , represented by S and sometimes referred to as mho) but for comparative purposes results are usually reported as electrical conductivity (EC), which is measured in S/m. Since most ground waters have conductivities of much less than 1 S/m (and since this method is often used to determine the TDS of ground water), it is often more convenient to use mS/m.

6.12.5.1 Basic Borehole Log User Interaction

These interactions are common to all measurement modes and thus will only be described in detail here and can be assumed for the following sub-Chapters.

- Selecting a measurement mode
 - Highlight the “Measure mode” row
 - Press <Left> and/or <Right> until the required mode is selected
- Starting a measurement
 - Highlight the “<Start>” row
 - Press <OK>
- Stopping a measurement
 - Highlight the “<Stop>” row
 - The <Start> row will change to <Stop> when a measurement is ongoing
 - Press <OK>
- Manually increasing or decreasing the probe level by the *Step Distance* (see page 44)
 - Highlight the “<Move Up>” or “<Move Down>” row
 - Press <OK>
 - The Probe level will be increased or decreased by the user-defined step distance (the *Minimum Electrode Spacing Z* multiplied with the step up or down interval multiplier)
- Editing the probe level manually
 - Highlight the *Probe level* row
 - Press <OK>
 - The numeric keyboard emulator will be shown
 - Enter a custom probe level, see Chapter 3.6.2 *The Keyboard Emulators*
- Editing the fluid level
 - Highlight the *Fluid level* row
 - Press <OK>
 - The numeric keyboard emulator will be shown
 - Enter the wanted fluid level, see Chapter 3.6.2 *The Keyboard Emulators*

Note! The *Down* and *Up* measurement modes automatically update the probe level after each measurement, ready for the next reading. Therefore, when readings switch from *DOWN* to *UP* logging, it will be necessary to step up one interval before measuring to repeat the reading taken on last *DOWN* measurement. This will be the correct position for the first of the *UP* measurements.

The <Start> row will change (Figure 86) if the *Safety Switch* button has been depressed (the secure locked position). In this case nothing will happen if the *Emergency Stop* row is selected and <OK> is pressed.

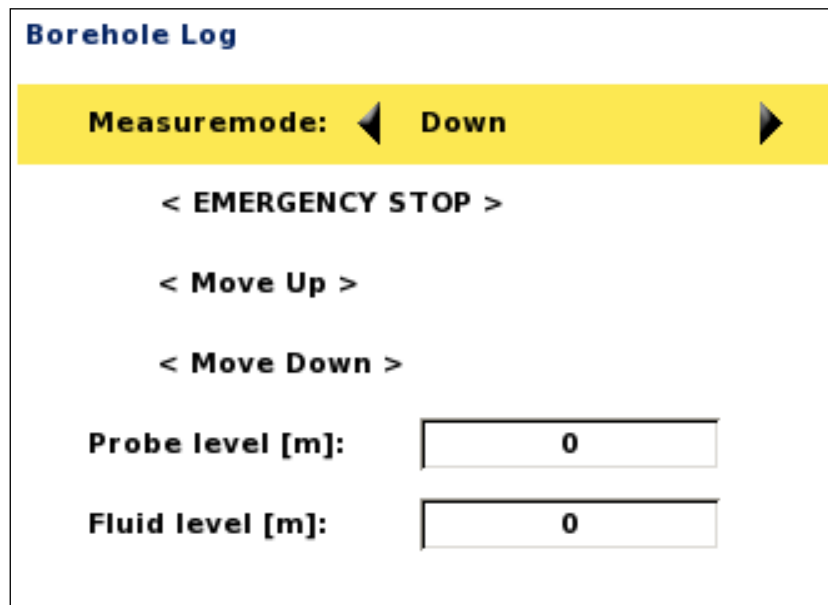

Figure 86 Emergency Stop notice on excerpt of the Borehole Log Page

For all measurement modes where current will be transmitted there will be a warning shown, see Chapter 6.10.1 *Starting the Measurement*.

Warning! Read the warning text (Figure 59) carefully before accepting to start the measuring process and carry out the data acquisition accordingly!

6.12.5.2 Electrode Test

Warning! Current will be transmitted through the probe as well as the C and P electrodes during the electrode test. Ensure all operatives are clear of the probe and remote electrodes for the duration of the test.

- Running an electrode test

- Select the *Electrode Test* mode
- Start a measurement
- Follow the instruction on the first dialog (Figure 87)
- Press <OK>
- When the electrodes have been tested the result will be displayed with the second or third dialog respectively (the resistance values will differ)
- Press <OK> to finish the test

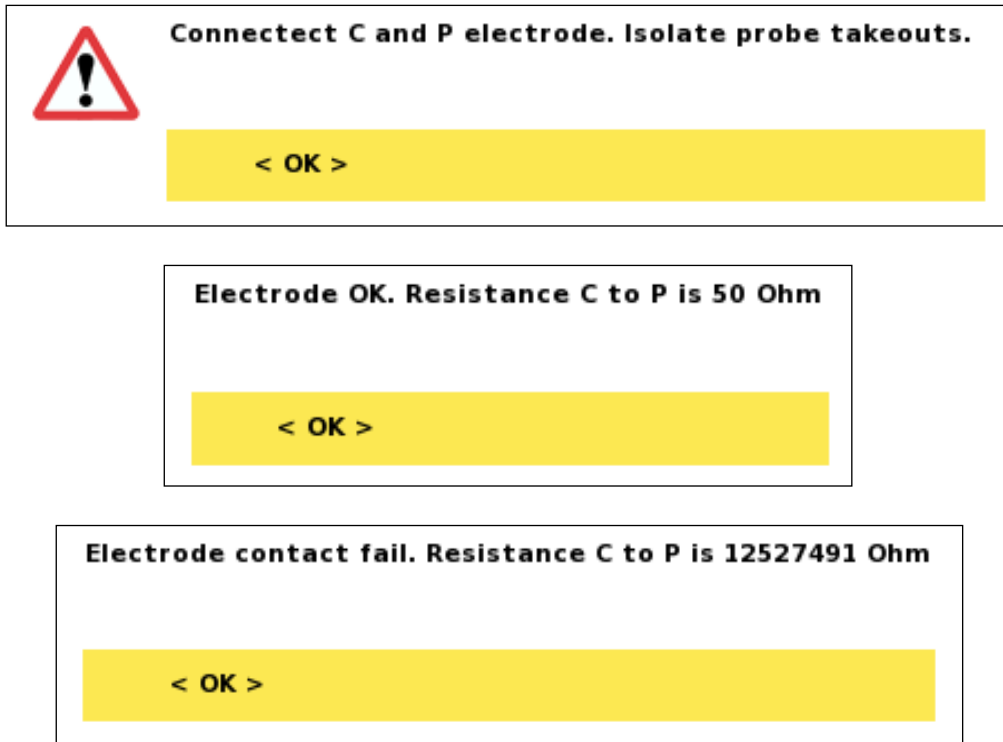

Figure 87 The Electrode Test dialogs

6.12.5.3 Depolarize

This process removes biased charges which may have built up on the electrodes. This is especially important when trying to take accurate SP measurements. Be aware that depolarization takes approximately 10 minutes.

- Running the depolarization routine

- Select the *Depolarize* mode
- Start a measurement
- Follow the instruction on the first dialog (Figure 88)
- After five minutes the second dialog will be displayed
- After five more minutes the depolarization will be completed

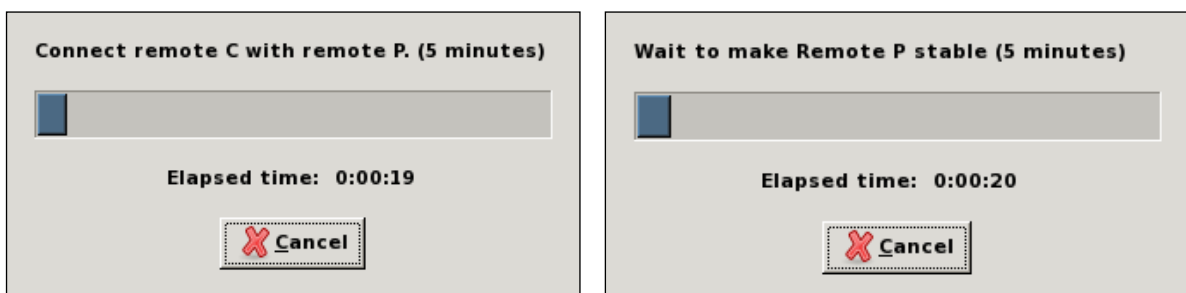

Figure 88 The two Depolarize dialogs

6.12.5.4 Level Check (Find water level)

- Running a level check

- Select the *Check Level* mode
- Start a measurement
- The first dialog (Figure 89) instructs the user to lower the probe into the well

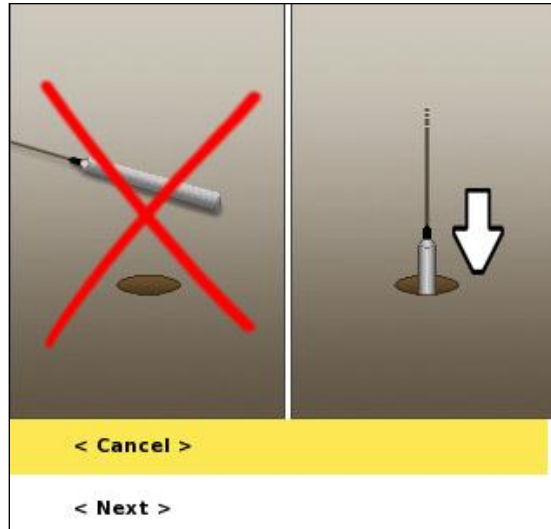

Figure 89 First Check level dialog

- Highlight the <Next> row and press <OK>
- A level indicator dialog is shown (Figure 90). The picture on the dialog will change automatically depending on whether water is detected or not, respectively showing that the probe should be lowered or raised to more accurately determine the water level.
- Repeat the lowering and raising of the probe with smaller and smaller distance increments until the water level is sufficiently correct.
- Highlight the <Next> row and press <OK>
- Edit the Fluid Level with the meter marking on the logging cable

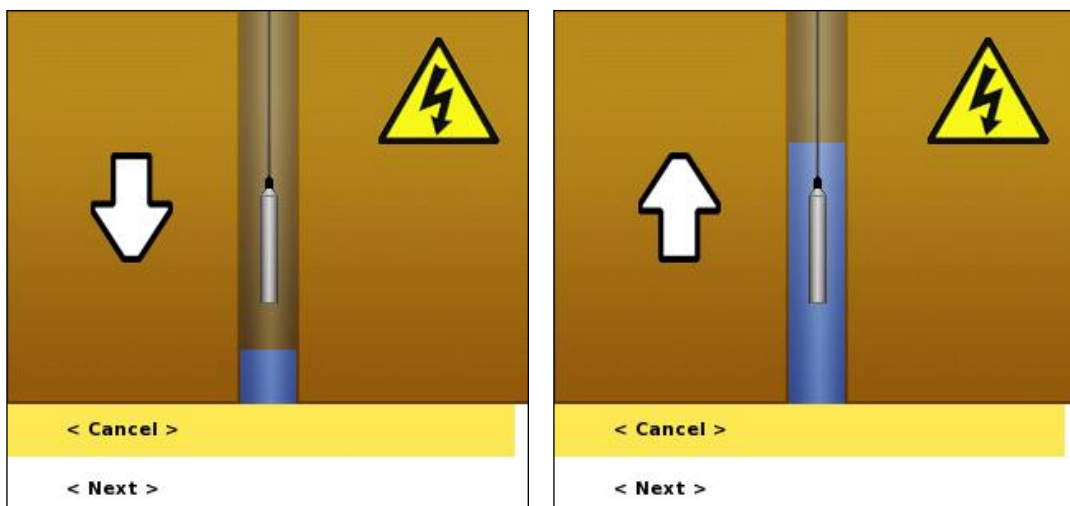

Figure 90 Level Indicator dialog

6.12.5.5 Down and Up measurement modes

These are designed to be the ‘normal’ measurement modes for borehole logging, used for the majority of measurements. These modes help to automate a logging session by automatically updating the *Probe Level* for the next measurement, indicating to the user what depth to lower or raise the probe to.

- Running DOWN logging

- Select the *Down* mode
 - Take a measurement
 - Note the new *Probe Level* and **lower** the probe accordingly
- Repeat these last two steps until the desired maximum depth is reached

- Running UP logging

- Select the *Up* mode
 - Take a measurement
 - Note the new *Probe Level* and **raise** the probe accordingly
- Repeat the last two steps until reaching the final position. Remember, if UP logging is to start at the same depth that DOWN logging finished, the probe depth must be edited first, as the software will have moved the depth position down one step automatically after the last DOWN log was taken.

Results are displayed in the table to the right side of the *Page* (Figure 91).

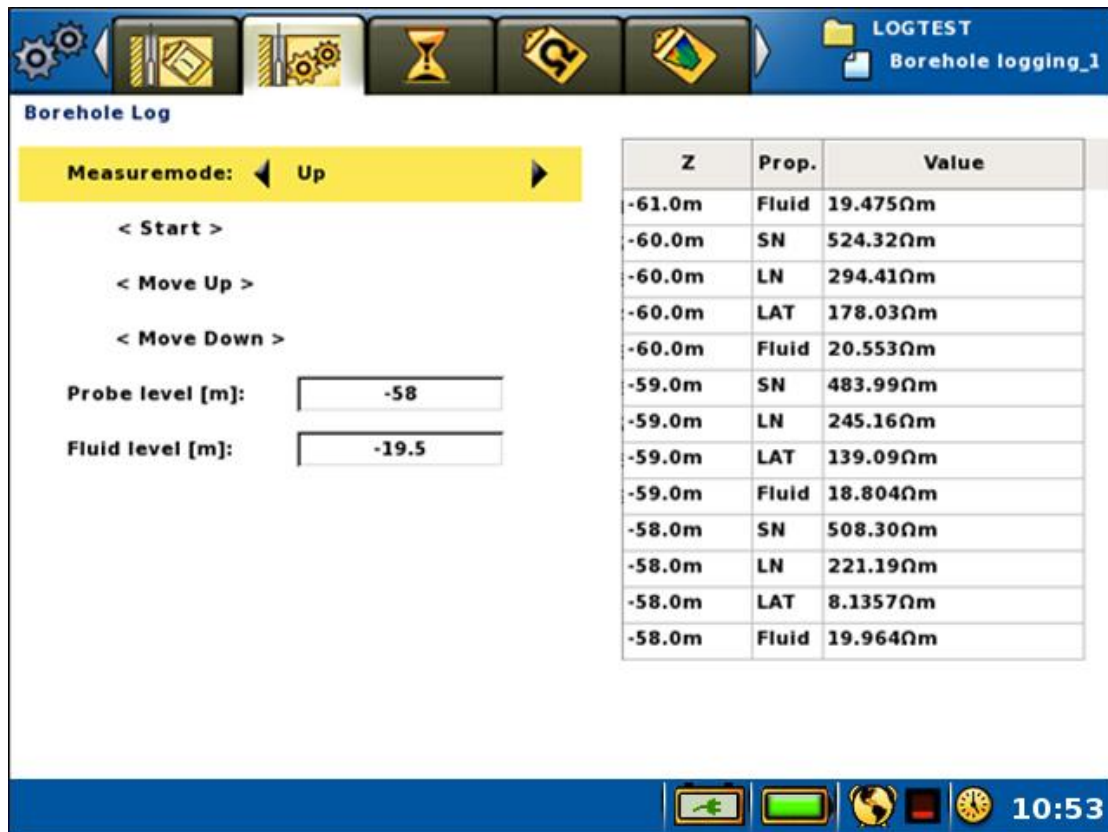

Figure 91 Borehole Log Page – table filled with measured values

6.12.5.6 Single value modes

These modes facilitate doing single value measurements, when appropriate. For example, when values might need to be measured one more time.

- Running single value borehole logging
 - Select the desired single value mode
 - Start a measurement
 - The measured value will be shown in the table

Note! <Move Up> and <Move Down> can be used before and/or after doing a single value measurement.

6.12.6 Working with Borehole Logging Data

The Terrameter LS 2 has a *Page* where the borehole logging data can be viewed as curves; this is the “Measurement/Borehole Log Curve” Page (Figure 92).

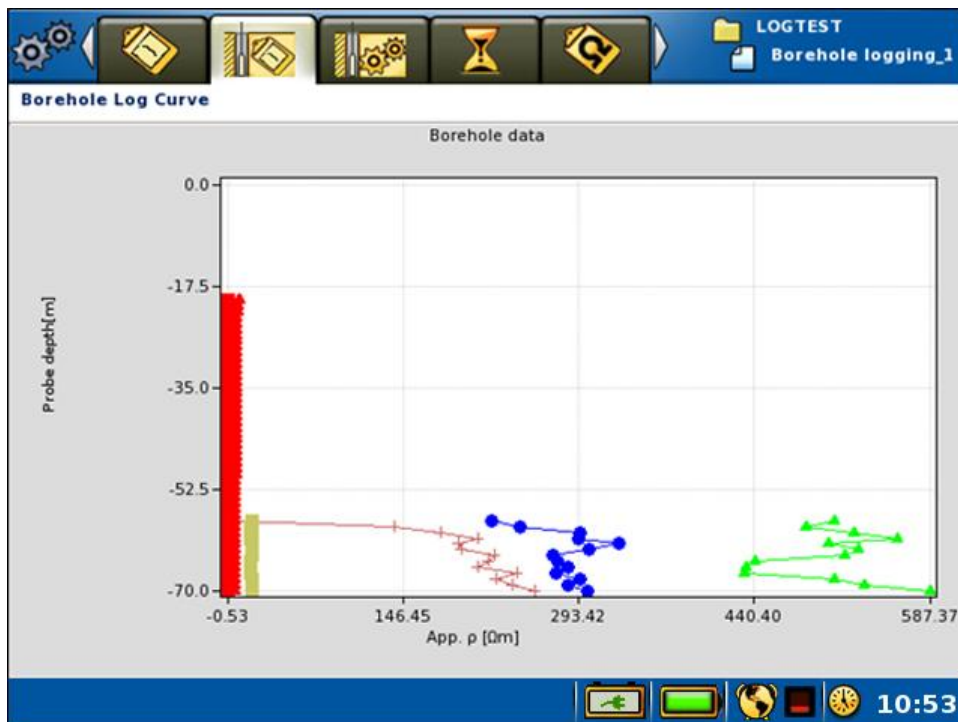

Figure 92 Borehole Log Curve Page

Legends used for the curves:

Variable	Icon
Temperature	Red squares
SP Voltage	Green triangles
Short Normal	Blue circles
Long Normal	Brown crosses
Long Lateral	Sand-yellow squares
Fluid Resistivity	Red triangles

The most commonly used data format for borehole measurements is LAS (Log ASCII Standard). It is normally recommended to download to the Terrameter LS Toolbox software first, and export to the desired format from there; however, the Terrameter LS 2 has an option to export logging data in LAS format to a USB memory stick (see Chapter 7.2.4 *Export a Task as a LAS File*).

There is no need to run inversion on borehole data, the raw recorded values can be used. A variety of dedicated software can plot borehole data from LAS format files, allowing creation of interpretative log diagrams. For more basic presentation, general-purpose spreadsheet / graphing software (e.g. Microsoft Excel, Google Sheets or Golden Software Grapher) can be used for the plotting of data. This may require some editing of the data file, for example removing the part of the file before the data section.

More information about the LAS file format can be found at the following website <http://www.cwls.org/products/#products-las>.

6.13 Measurement Errors

A number of different errors or warnings can occur while measuring. This Chapter explains the general handling of these errors and warnings as well as additional information about some specific examples.

A *Measuring Error* dialog will be shown when a problem occurs during a measurement cycle. Figure 93 shows an example.

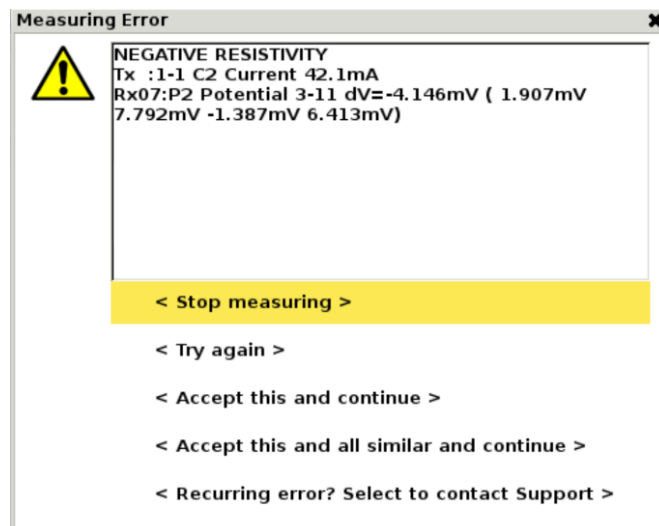

Figure 93 A *Measuring Error* dialog example

The layout of the dialog is always the same. The box in the top half of the window contains general event information, with a series of details about the measurement on which the error occurred and sometimes, when appropriate, problem-solving suggestions. For the measurement details, four values can be given:

- **Tx:** lists the electrodes involved in current transmitting
- **Estimated load:** the load as measured by the current transmitter between Tx pair
- **Current:** the transmitted current as measured by the current transmitter
- **Status code:** the status code number as well as one or more describing texts

In the lower portion of the dialog there are five commands listed. These commands are as follows:

- **Stop measuring:** The measurement stops. Works just like the stop command on the *Progress Page*.
- **Try again:** The measurement is restarted from the failed data point. The error dialog will be shown again if the error persists.
- **Accept this and continue:** The data point is marked as failed and the measurement is resumed with the next data point. The error dialog will be shown again for the same type of error occurring later.
- **Accept this and all similar and continue:** The data point is marked as failed and the measurement is resumed with the next data point. The error dialog will **not** be shown again for the same type of error occurring later in this measurement.
- **Recurring error? Click here to contact support:** this opens a window with a QR code which will automatically generate a proforma email to support.

Figure 94 has some further examples of the information from different measurement errors.

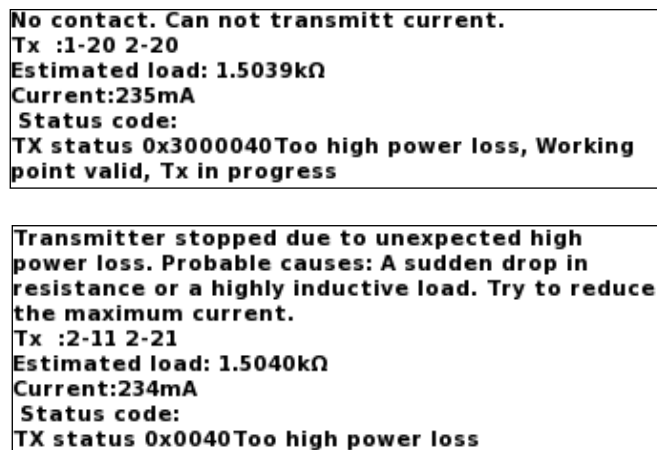

Figure 94 Examples of measurement error messages

A selection of possible messages are as follows:

Emergency stop	The safety stop switch on the end-panel has been pressed
Power source low voltage	Check the health of the internal and/or external battery. Note that a 12V lead-acid battery, with no load on it, showing 12.0V on a regular test meter is at around 25% charge. A healthy, fully-charged lead-acid battery should show 12.6V – 13.2V
Load resistance too high or No contact?	Contact between LS and electrode(s) might be bad. Check all connections and cables Or Contact between electrode(s) and ground might be bad. Use one of the common methods of improving contact resistance, i.e. watering electrodes (with salt water if necessary), hammering electrodes deeper, using multiple electrodes, using a conductive medium like clay or an electrolyte gel, adding plate electrodes etc.

Negative resistivity	<p>Attempting to repeat the measurement will often clear the problem. However, there are several reasons why persistent negative resistivity values get recorded. These include: poor electrode contact, a depleted battery, bad instrument settings, buried debris and/or utilities, environmental factors, or damaged cables/connectors/relays. You can find out more in this article:</p> <p>https://www.guidelinegeo.com/help-articles/negative-resistivity-why-am-i-getting-negative-resistivity-values/</p>
<p>Transmitter stopped due to unexpected high power loss. Probable causes: A sudden drop in resistance or a highly inductive load. Try to reduce the maximum current</p>	<p>Measurement stopped to prevent the transmitter from being damaged and/or avoid poor data quality due to rapid variation in output current/voltage. This can happen in areas where there is a lot of metallic debris or utilities beneath, or very close to, the electrode spread. Try the proposed action or increase the “Load Variation Margin” in the <i>Transmitter Settings Page</i>.</p>
<p>Transmitter inhibited by hardware safety signal from main CPU board</p>	<p>Possible problem with generating the necessary current output. Retry measurements and contact support if problem persists.</p>
<p>Transmitter high temperature (overheat)</p>	<p>Try shading the instrument with an umbrella/parasol to keep the instrument out of direct sunlight. The ribbed plate on the left-hand end-panel of the instrument is the colling plate, try to get air moving across it or event apply a damp cloth to it.</p>
<p>Transmitter stopped due to unexpected error</p>	<p>Retry the measurement initially; if the problem persists contact support.</p>
<p>Transmitter setup fail</p>	<p>Possible problem with initialising the transmitter for current injection. Retry measurement and contact support if problem persists.</p>
<p>Relay expected on is off</p>	<p>There are very many mechanical relays in the switch matrix and sometimes one can either stick or end up in an incorrect state. Rebooting the instrument will ‘exercise’ the relays and should solve the problem. If the warning repeats regularly, contact support.</p>
<p>A/D data read error</p>	<p>Digitizer on one of the measurement channels has malfunctioned. Try measuring again, if problem persists contact support.</p>
<p>ES10-64 not ready</p>	<p>Normally a temporary break in communication between the Terrameter and the ES10-64C. The instrument normally retries the connection automatically and continues. If not, manually retry measurement and if problem persists contact support.</p>
<p>Software Exception</p>	<p>Normally an error with the firmware or user software. Attempt measurement again and/or a reboot. Contact support if issue repeats.</p>

6.14 Full Waveform Data

Internally the instrument records data with the sample rate selected in the “*Settings/Receiver settings*” Page. This data is filtered and averaged in order to provide the measured current, voltages, resistance, and chargeability that are displayed and saved. The full waveform data does not *have* to be saved for the majority of projects but the option to do so is available to allow detailed analysis, or very advanced processing, of the received signals afterwards.

Full waveform data plots make it possible to identify and understand, for example, the presence of excessive power line network noise, telluric noise, signal disturbances caused by cable coupling and such like. This may then be useful as input for how to optimise the data acquisition process, especially for IP measurements which are more sensitive to noise than resistivity measurements.

Chapter 5.2.2 *Data Acquisition Settings* describes how this feature is turned on or off. Be aware that turning the feature on means saving large amounts of data, formed from a very large number of individual files, that can fill the disk and will take significant time to transfer from the instrument to a PC. It is not recommended to attempt to copy a *Project* containing full waveform data to a USB disk, as it will take a very long time.

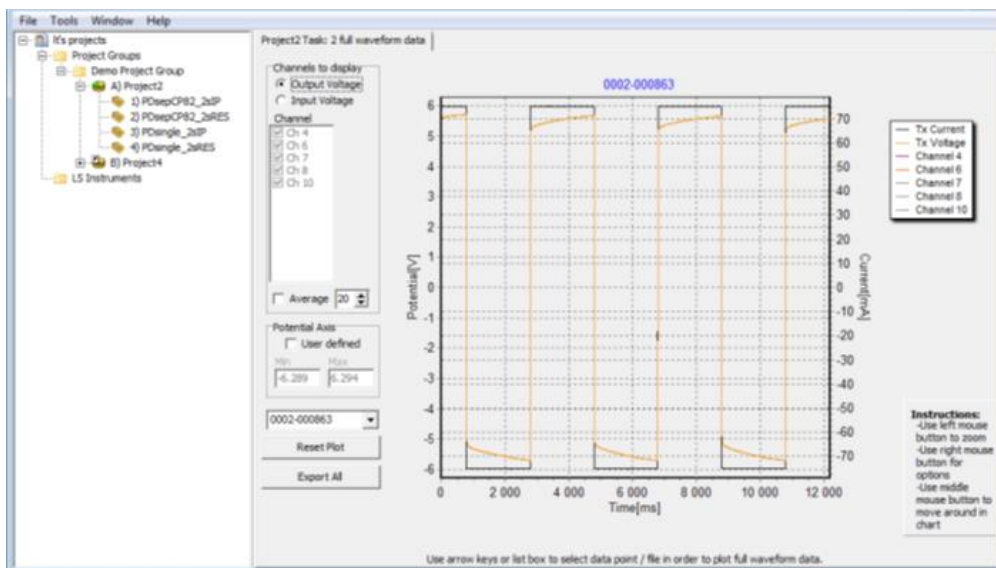

Figure 95 Full waveform data viewed in Terrameter Toolbox

6.15 100% Duty Cycle IP Mode

The ABEM Terrameter instruments, as with most field resistivity/IP systems, use the time domain method to collect IP data. This method has traditionally used what is called a 50 % duty cycle - this means that measurement periods are divided into two equal parts. During the first part, the ON time, current is transmitted into the ground to charge it. During the second part, the OFF time, no current transmission is made, instead the instrument measures how the voltage decays as the ground discharges. During the ON time resistivity data are measured and during the OFF time IP data are measured.

With the Terrameter LS 2 it is possible to measure IP using 100% duty cycle. This means that there is no OFF time, and that current is always transmitted into the ground. Instead of measuring IP when the ground is discharging, IP will now be measured during the early part of the ON time as the ground is being charged. With this new measure mode both resistivity data and IP data will be measured during the ON time, and the OFF time is not needed.

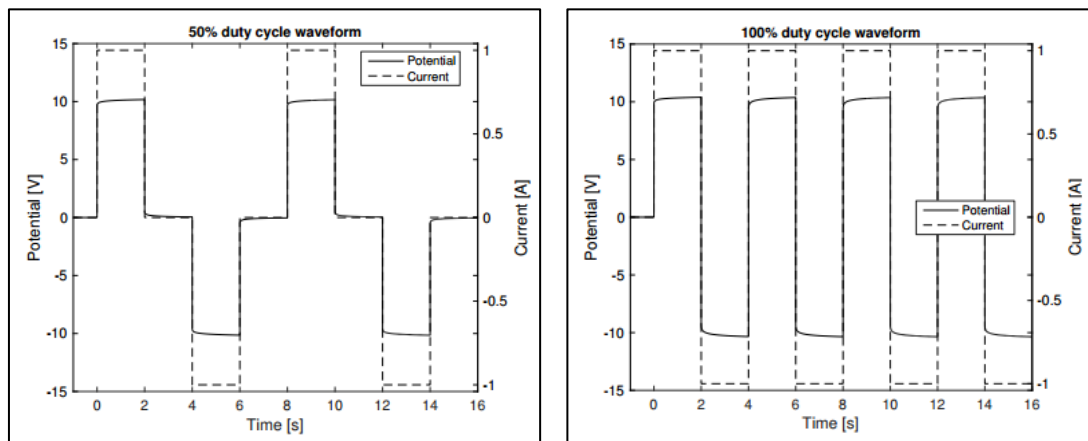

Figure 96 Traditional 50% duty cycle IP measurements (left) versus 100% duty cycle measurements over the same time period

The main advantages of utilising the 100% duty cycle mode are:

- Using a 100 % duty cycle, IP data can be collected twice as fast as when using the ‘standard’ 50 % duty cycle.
- As the signal to noise ratio is twice as high using the new method, IP data quality will be improved.
- Exponential SP trend removal (introduced with the 100% duty cycle mode) makes the IP calculations more accurate.

These are important factors which can limit the need for external high-power transmitters in some environments.

For more information on the 100% duty cycle IP measurement mode see Chapter 9.4 *Induced Polarisation (IP): “RES, IP100” Measurement Mode*

7 POST-MEASUREMENT ACTIVITIES

7.1 Repacking the LS system

Cleaning and repacking the equipment properly will give your instrument a longer life. Below we have tried to specify key areas for maintenance of this instrument.

- Check that all pieces of equipment are collected from the field; a basic checklist is a simple means of keeping track of all the equipment.
- Clean each part thoroughly, if needed by washing and drying; check connectors for dirt and foreign objects.
- Always store the instrument dry in its original travelling package.
- If conditions were particularly wet, or you have washed the instrument, leave the instrument and accessory dust caps off for a while (once the equipment is in a dry location) to ensure connectors are fully free of moisture before storing the equipment.
- It is recommended to store the instrument with charged internal battery pack(s) to maximise battery longevity.

7.2 Export Measurement Data

To enable analysis and processing of the recorded data, it can be exported from the instrument in a variety of ways. The choices are exporting directly to a USB memory stick connected to the Terrameter, which is described in the following sub-Chapters, or by using the Terrameter LS Toolbox software package (via Ethernet or Wi-Fi connection), see Appendix D. *Terrameter LS Toolbox* overview.

Note! It is strongly recommended for users to always transfer the *Project* database and store it for future use. It may turn out that more information than the standard export formats provide becomes desirable. Also, in case assistance is required from Guideline Geo’s support department, you are likely to be asked to send the *Project* database file as it contains essential information for efficient instrument diagnostics.

7.2.1 Export a Task as a DAT File

Data can be exported as a DAT-file (Res2Dinv compatible format) to a PC via a USB memory stick connected to the USB port on the Terrameter, for analysis, processing and presentation.

- Export as a DAT file
 - Navigate to the “Projects/Task List” Page
 - Highlight the *Task* to export
 - Press <Options>
 - Highlight <Export task as DAT> (Figure 97)
 - Press <OK>



Figure 97 Task options menu

Confirm that you want to export to the USB memory device (Figure 98).

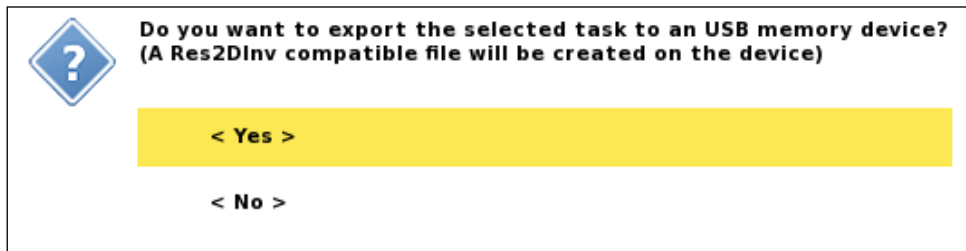

Figure 98 Export task to DAT confirmation dialog

Note! If there is no USB memory device inserted, or there is a problem with the device, the export options will be greyed out.

7.2.2 Export a Task as a TXT (Text) File

- Export as a TXT file

- Navigate to the “Projects/Task List” Page
- Highlight the *Task* to export
- Press <Options>
- Highlight <Export task as TXT> (Figure 99)
- Press <OK>



Figure 99 Task options menu

Confirm that you want to export to the USB memory device (Figure 100).

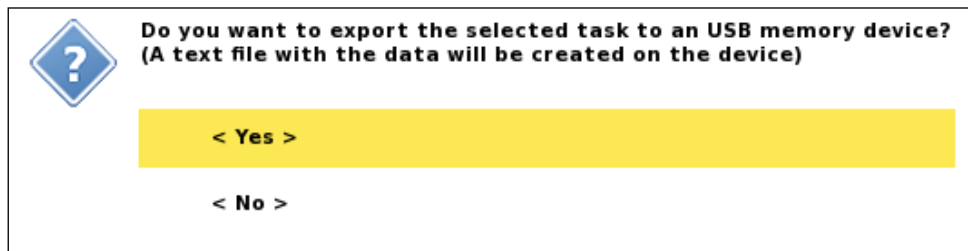

Figure 100 Export task to TXT confirmation dialog

7.2.3 Export a Task as a USF File

USF is the acronym for Universal Sounding Format which is an industry-standard file format suitable for VES data.

- Export as a USF file

- Navigate to the “Projects/Task List” Page
- Highlight the *Task* to export
- Press <Options>
- Highlight <Export task as USF> (Figure 101)
- Press <OK>



Figure 101 Task options menu

Confirm that you want to export to the USB memory device (Figure 102).

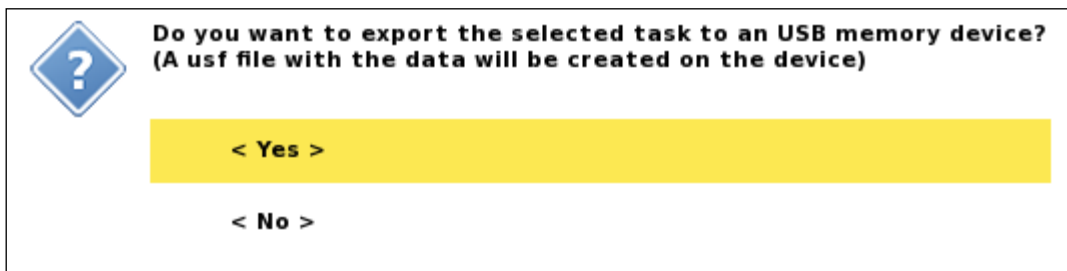

Figure 102 Export task to USF confirmation dialog

7.2.4 Export a Task as a LAS File

LAS is the acronym for “Log ASCII Standard” which is an industry-acknowledged file format suitable for borehole log data.

- Export as a LAS file

- Navigate to the “Projects/Task List” Page
- Highlight the *Task* to export
- Press <Options>
- Highlight <Export task as LAS> (Figure 103)
- Press <OK>

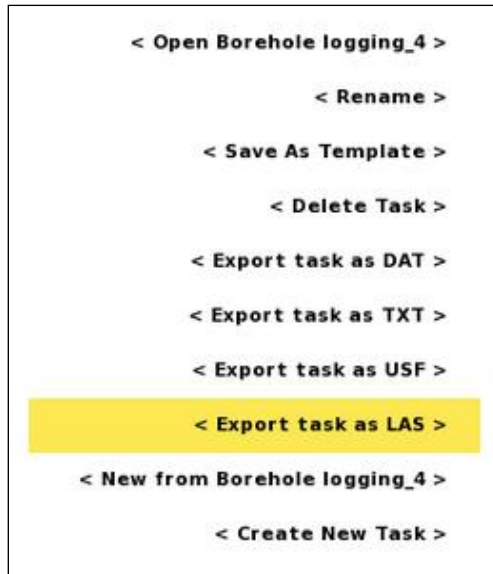

Figure 103 Task options menu

Confirm that you want to export to the USB memory device (Figure 104).

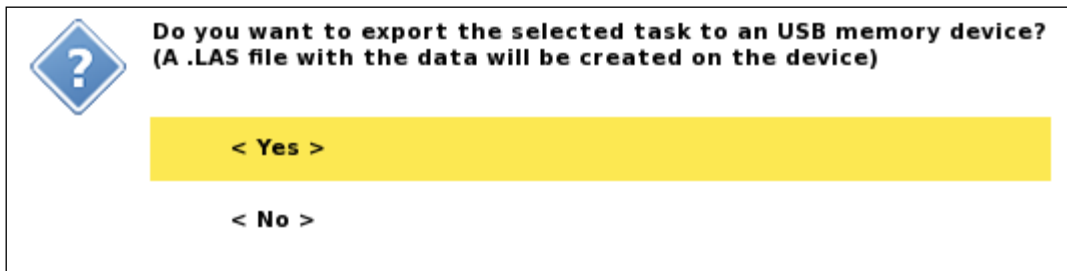

Figure 104 Export task to LAS confirmation dialog

7.2.5 Export a Project

A complete *Project* can be exported to a USB memory stick or disk drive. This will copy the *Project* database which can then be read into the Terrameter LS Toolbox software package. If tasks were acquired including full waveform data then all files associated with this will be copied as well.

Note! Exporting *Projects* with full waveform data may take several minutes, or even tens of minutes for larger *Projects*, and it is often a better option to copy the data via Terrameter LS Toolbox and an Ethernet or Wi-Fi connection instead.

- Export a *Project*

- Navigate to the “Projects/Project List” Page
- Highlight the *Project* to export
- Press <Options>
- Highlight <Export Project> (Figure 105)
- Press <OK>

Confirm that you want to export to the USB memory device (Figure 106).



Figure 105 Project options menu

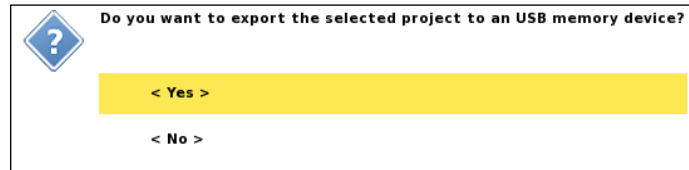

Figure 106 Export Project confirmation dialog

7.3 Delete a Project

- Deleting a Project

- Navigate to the “Projects/Project List” Page
- Highlight the *Project* to delete
- Press <Options>
- Highlight <Delete Project> (Figure 107)
- Press <OK>

Confirm that you want to delete the *Project* (Figure 108).

Warning! This will delete all data in the *Project* permanently! Be sure to have a back-up

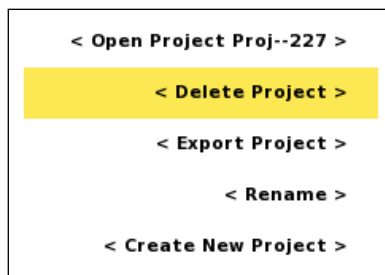

Figure 107 Project options menu

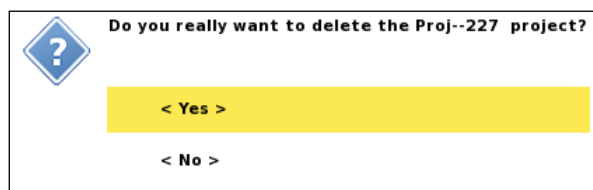

Figure 108 Delete confirmation dialog

8 TESTING, DIAGNOSTICS AND FAULT FINDING

The Terrameter LS 2 has built-in self-test and calibration of the major functions, including input boards, transmitter and relay switch. Test results are automatically logged for quality assurance purposes, and any malfunction reported to the operator. Temperature and power supply voltage is constantly monitored and logged.

8.1 Self Test

A self-test can be carried out which will run measurements across internal reference circuits to determine that the recording channels and transmitter are working correctly. The test is carried out in the following way:

1. Disconnect all electrode cables or other devices connected to the input panel.
2. Navigate to the “*Settings/Receiver*” Page and set:
 - “Mode” to “RES” (other settings are not important)
3. Navigate to the “*Settings/Transmitter*” Page and set:
 - “Electrode Test” to “No”
 - “Maximum Voltage” to “600”
 - “Minimum Current” to “1mA”
 - “Max Current” must be selected according to the quality of the available power supply. If the power output is limited (i.e. the included Terrameter LS 2 Office Power Supply) it is acceptable to run with, for instance, 50 mA. If a suitable source of power is available (e.g. 12 Volt battery or optional ABEM Power Adapter) current values up to 2500mA can be selected and a more complete self-test will be achieved.
4. Create a new *Task* and select the spread “LS internal” and the protocol “Selftest”.
5. Start the measuring procedure.
6. Voltage measurements are taken with each measurement channel across the built-in reference voltages, which have been chosen to trigger the different measurement ranges. Furthermore, resistance measurements are taken through built-in 1.5 Ohm and 33 kOhm resistors.
7. After measuring is completed, the results can be exported as a text-file for inspection and as quality assurance documentation. The nominal values for each channel are shown in the text-file with the “note” column indicating which test each line refers to. Note that the test resistors are not precision resistors and deviations in the range of 10% from the nominal value are normal.

Warning! Do not run a self-test using the office power supply; a 12V battery or the ABEM Power Adapter (10-006021) are recommended.

8.2 Cable Continuity Test

A cable continuity test is used to check there are no breaks along the individual strands of wire within the spread cables. Breaks can cause problems when trying inject current and/or produce negative readings.



HIGH VOLTAGES WILL BE PRESENT ON THE ELECTRODE TAKE-OUTS DURING THIS TEST. MAKE SURE NOTHING, AND NO-ONE, IS TOUCHING THE ELECTRODE SPREAD CABLE(S) DURING THE CABLE CONTINUITY TEST.

The continuity test can be carried out as follows:

1. Connect one end of an electrode spread cable to “Connector 1” and the other end to “Connector 2” (not possible on the VES MAX edition). Make sure that the electrode take-outs do not touch each other or anything else.
2. Create a new *Task* and select the spread “CableTest” and the protocol “CableContinuityTest”.
3. Navigate to the “Settings/Transmitter” Page and set maximum output current to 20mA.
4. Make sure that “Electrode Test” is set to “No”.
5. Start the measuring procedure. If the cable is good, it should be possible to take all measurements in the protocol. If there is any problem transmitting current there is a problem with the cable.

Note! All cores in a given cable set should return a similar resistance; the absolute value will be a result of the cable length and temperature.

6. Repeat the procedure for all electrode cables.
7. After measuring is completed, the data can be downloaded in LS Toolbox for inspection and exported in text format as quality assurance documentation. Alternatively, the file can be exported to text direct from the “Task List” Page.

8.3 Cable Isolation Test

A cable isolation test is used to check there is no contact between the individual strands of wire within the spread cables, or between the pins in the connectors. This unwanted connection can be due to breaks in the insulation around the strands, moisture or dirt between the pins, or burns on the connectors from short-circuits due to that moisture/dirt.



HIGH VOLTAGES WILL BE PRESENT ON THE ELECTRODE TAKE-OUTS DURING THIS TEST. MAKE SURE NOBODY AND NOTHING TOUCHES THE ELECTRODE CABLE(S) DURING THE CABLE ISOLATION TEST.

A cable isolation test can be carried out as follows:

1. Electrode cables to be tested should be connected to “Connector 1” or “Connector 2” on the end panel of the instrument. One or two electrode cables can be tested at the same time. If two cables are to be tested (Figure 109), then one cable should be connected to each of the connectors (1 and 2).

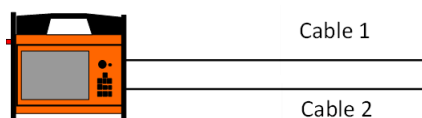

Figure 109 Two cables connected for cable isolation test

Note! Only one end of the cables being tested should be connected to the instrument. The other end must be left free.

2. If only one cable is to be tested, then using “Connector 1” will write the test results to the top of the electrode list (see below).
3. Make sure that nothing else is connected to the cable and that the electrode take-outs do not touch each other or anything else, including personnel.
4. Create a new *Task* and select the spread “CableTest” and the protocol “CableIsolationTest”.
5. Navigate to the “*Settings/Transmitter*” Page and make sure that “Electrode Test” is set to “Yes”.
6. Start the measuring procedure, which will start with the electrode contact test.
7. Navigate to the “*Measure/Electrodes*” Page to check the result of the test. If the cable is Ok there should **not** be contact on any of the electrodes along the cable(s); that is, the text in the *Ohm* column should read “*No contact*” for all electrodes. If there is any connection (see Figure 110) there is a problem with the cable.
8. By disconnecting the cables and re-running the test, it is possible to assess the instrument panel connectors themselves for isolation. The result should indicate “*No contact*” on all measurements for a successful test.

S	Takeout	Pos	Ohm	Status
	CableTest	0;0;0		
1				
1-1		0;0;0	*No contact*	(AB:1 MN:1)
1-2		2;0;0	*No contact*	(AB:1 MN:1)
1-3		4;0;0	*No contact*	(AB:1 MN:1)
1-4		6;0;0	*No contact*	(AB:1 MN:1)
1-5		8;0;0	8.09 0 Ok	(AB:1 MN:1)
1-6		10;0;0	*No contact*	(AB:1 MN:1)
1-7		12;0;0	*No contact*	(AB:1 MN:1)
1-8		14;0;0	*No contact*	(AB:1 MN:1)
1-9		16;0;0	*No contact*	(AB:1 MN:1)
1-10		18;0;0	*No contact*	(AB:1 MN:1)
1-11		20;0;0	*No contact*	(AB:1 MN:1)
1-12		22;0;0	*No contact*	(AB:1 MN:1)
1-13		24;0;0	*No contact*	(AB:1 MN:1)
1-14		26;0;0	*No contact*	(AB:1 MN:1)
1-15		28;0;0	*No contact*	(AB:1 MN:1)

Figure 110 The Electrodes Page showing the result for a faulty cable

8.4 Cable Joint Tests

There are two cable joint tests which may be performed. These tests will test for continuity and isolation. Note that these tests require the cable joints to be connected to imaging cables so it may be important to test those cables first.



High voltages will be present on the electrode take-outs during this test. Make sure nobody and nothing touches the electrode cable(s) during the cable isolation test.

A cable joint continuity test is used to check there are no breaks within the internal connections of the cable joint.

A cable joint continuity test can be carried out as follows:

1. Connect the low numbered take-out end of one imaging cable into Connector 1 of the instrument panel. Connect the high numbered take out end of a second imaging cable into Connector 2 of the instrument panel.
2. Connect the cable joint between the two imaging cables. Make sure the connector is connected to the cables such that the grooved end points towards Connector 1, as shown below.



Figure 111 Correctly configuring a Cable Joint for testing

3. Create a new *Task* and select the spread “CableTest” and the protocol “Cable joint test”.
4. Navigate to the “Settings/Transmitter” Page and set maximum output current to 20mA and set Electrode test to “No”.
5. Start the measuring procedure. If the cable and cable joint are working correctly, the instrument should be able to take all measurements within the protocol. If there are any problems transmitting current there is a problem with the cable joint.
6. Test other cable joints for continuity by swapping the cable joint and repeating the test as described above.

A cable joint isolation test is also possible and is used to check there is no contact between the individual connections within the cable joint, or between the pins in the connectors. This unwanted connection can be due to breaks in the insulation around the strands, moisture or dirt between the pins, or burns on the connectors from short-circuits due to that moisture/dirt. The procedure for a cable joint isolation test is as follows:

1. Run a cable isolation test on an imaging cable as described in Chapter 8.3 *Cable Isolation Test*.
2. If the cable isolation test passes, then it is possible to use this cable to test the cable joint. To do this take the free end of the cable and connect the cable joint. The grooved end of the cable joint should point towards the instrument.
3. Re-start the cable isolation test procedure using the same settings. Note that if you have just run the cable isolation test then the settings will be correct.
4. Navigate to the “Measure/Electrodes” Page to check the result of the test. If the cable joint’s isolation is there should **not** be contact on any of the electrodes along the cable(s); that is, the text in the *Ohm* column should read “*No contact*” for all electrodes. If there is any connection shown (see Figure 110) there is a problem with the cable joint.

8.5 Remote Diagnostics

The Terrameter LS 2 can be connected to ABEM for remote diagnostics over a VPN (Virtual Private Network). To connect the instrument to our VPN you need a standard Ethernet based TCP/IP LAN (Local Area Network) that is connected to the Internet. The instrument is connected to the LAN with a RJ-45 cable. It is advisable to connect the instrument to the network before it is switched on.

If the LAN has a DHCP service, the instrument will acquire an IP number and most likely the other required network settings from the DHCP server when the network service starts. Note that the DHCP server must allow unregistered MAC addresses. If it does not, the instrument's MAC address must be registered in it. Please contact your local network administrator if this is necessary. To find the instrument's MAC, see the "Instrument/Network" Page.

Restrictions: The LAN router or firewall must not block outgoing traffic on port 1194, and must allow incoming traffic that is initiated from inside the LAN to be returned to the instrument. Further, if the LAN is using NAT, it must not use the private IP network 10.17.23.x since the VPN will be using it. Most office LANs will meet these specifications.

If you are not familiar with the terminology in this section, and experience problems with the connection, please contact your local network administrator.

The instrument automatically tries to establish a secure network connection to the ABEM support server. This will succeed if the instrument has a network connection that allows VPN communication with the ABEM office www.abemoffice.com and port 1194.

A successful connection will add a tun0 line on the network information page:

```
eth0 : 192.168.10.64
tun0 : 10.17.23.26 The "tun0" address is provided to a Terrameter from the support server
```

Please note: Some countries/companies have firewall rules that blocks access to this type of service.

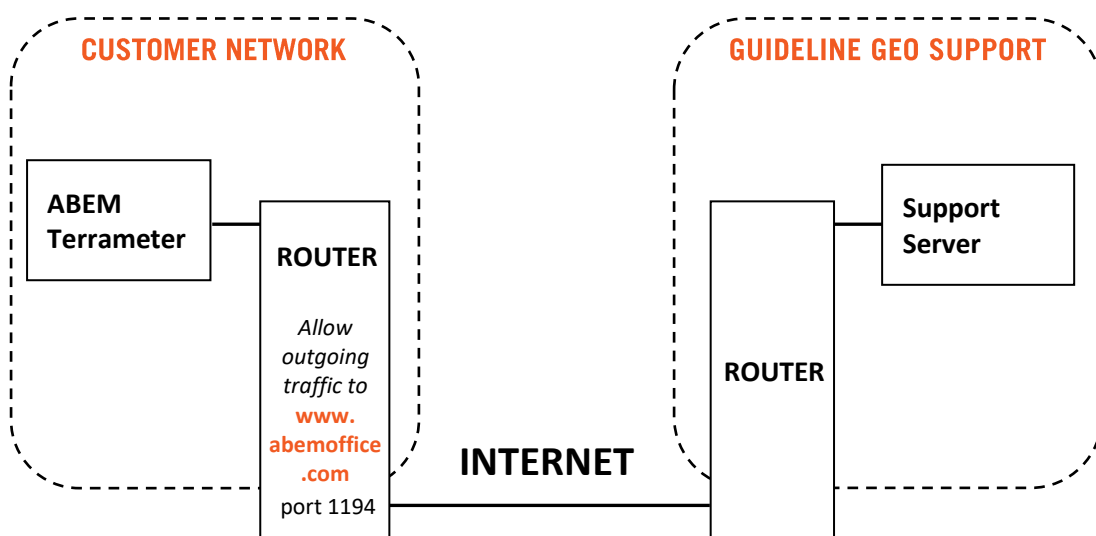

Figure 112 Remote diagnostics over VPN

8.6 In Case of Malfunction

In case of malfunction please carry out applicable tests as described in this manual. If it is not possible to find the cause of the problem, send a description of the issues via e-mail to support@guidelinegeo.com. Any communication with the Support department should include instrument type, serial number and, if possible, the original ABEM order number. Be prepared that support engineers may request a copy of the project database from the time of the problem (for details on downloading this see Appendix D. *Terrameter LS Toolbox* overview), or for the instrument to be connected to the internet to carry out testing; follow the instructions in Chapter 8.5 Remote Diagnostics.

Should a fault occur that cannot be resolved on site, instructions on returning the instrument will be supplied. Freight to Guideline Geo must be prepaid. For damage or repairs outside the terms of the ABEM warranty, Guideline Geo will submit an estimate before undertaking any remedial work.

Be sure to fill in the warranty registration card (included with the equipment) correctly and return it to Guideline Geo promptly. This will help us process any claims that need to be made under the warranty. It will also help us keeping you informed about any software and firmware upgrades made available through our downloads page. ABEM welcomes your response and feedback at any time but please let us know your name and address, and the serial number of the instrument.

9 APPENDIX A. MEASUREMENT MODES

In SP, Resistivity and IP data acquisition, it is essential to suppress various types of noise from sources such as electrode polarisation, telluric currents, electrical distribution networks and industry. The Terrameter LS 2 is equipped with sigma-delta AD-converters which have some built-in low-pass filtering and excellent noise suppression. However, low-pass filtering cannot be used in its standard form for IP measurements, since it would colour early time IP data strongly. Instead, proprietary signal processing is used to suppress noise whilst, at the same time, resolving early time IP decay signals. The following parameter definitions are used:

PARAMETER	DESCRIPTION
Powerline frequency	To be set to match local power net grid (50Hz or 60Hz)
Delay time	Delay from current turn-on until measuring starts (for instance 300ms / 0.3s)
Acquisition time	Integration time (for instance 500ms = 25 samples @ 50Hz)
Number of IP windows	Number of time windows within which signal integration is used to record chargeability (for instance 10)
IP delay time	Delay from current turn-off until IP measuring starts (for instance 10ms / 0.01s)
IP integration time(n)	Signal integration time for a given IP time window (for instance 20ms / 0.02s), later windows should, ideally, have longer periods.

The measuring cycles used in DC resistivity and time domain IP surveying eliminate zero shifts by taking the average of data measured on positive and negative current pulse. Furthermore, the measuring cycles are inherently designed to minimise errors due to variation in background potentials during the measuring cycle.

9.1 Self-Potential (SP)

Self-potential measurements are done by simply integrating input voltages over the specified acquisition time interval and, if so selected, stacking and averaging the results. Care should be taken to select the base frequency and acquisition time so that sufficient averaging and noise suppression is achieved.

In areas likely to be affected by 16 2/3 Hz noise from railway power supply (some areas of Northern Europe) it is essential to select an acquisition time that is a multiple of 60 milliseconds to suppress such noise purely through the averaging process as there is no in-built filtering for this frequency of sinusoidal noise. This applies to resistivity and IP data acquisition as well.

Self-potential survey must be undertaken using non-polarising electrodes to eliminate the (relatively large compared to SP effects) voltages generated by pushing steel electrodes into the ground. With non-polarizing electrodes, the solid metal element of the electrode is surrounded by a conductive fluid or compound which is what contacts with the ground and allows the voltage to be measured.

9.2 Resistivity: “RES” Measurement Mode

In the case of resistivity measurement, the measuring cycle consists of a positive, a double negative and again a positive current pulse (Figure 113). By averaging the measured voltages, any zero-offset and all linear drift during the measuring cycle is eliminated.

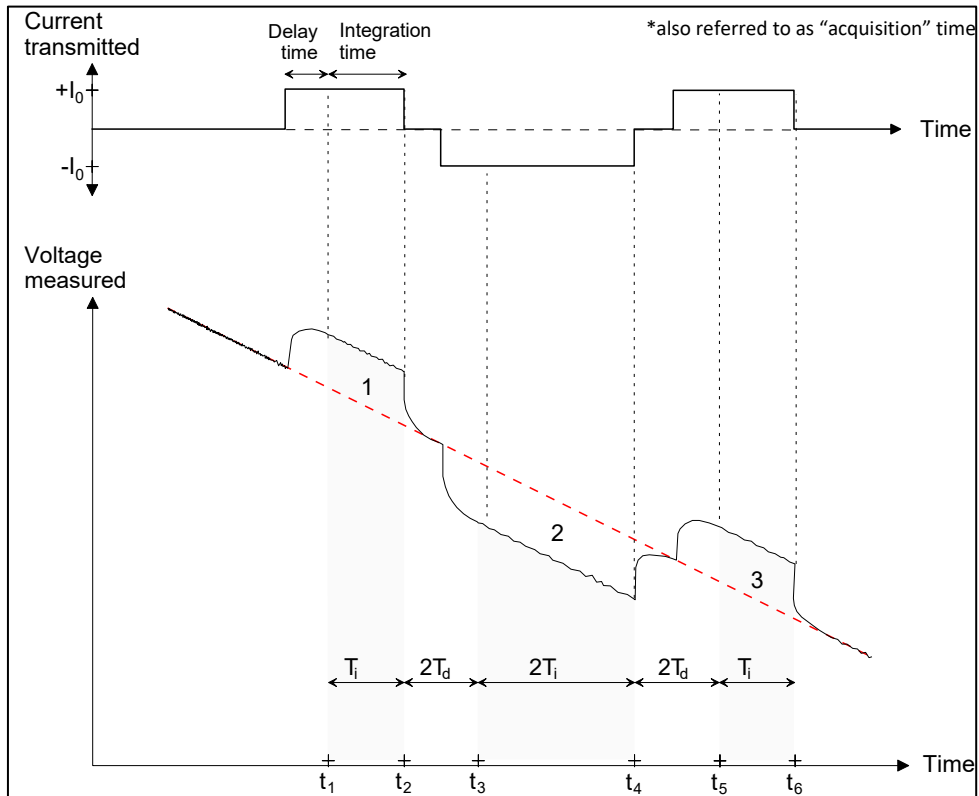

Figure 113 Resistivity measuring cycle timing definitions, after Krill (Krill P. 1979. JRM2 - ett jordresistansmätande instrument. Report AE1-79, Physics Department, Lund University)

9.3 Induced Polarisation (IP): “RES, IP” Measurement Mode

In the case of time domain IP measuring one positive and one negative current pulse is usually employed. These are typically symmetrically timed but as a minimum the IP off time should be equal to the current on time. It is then necessary to measure the background voltage levels before and after the current pulses and IP recording periods, and use that for removing drift during the measuring cycle (Figure 114). Failure to do so can lead to a magnitude increase in measurement errors within the resistivity data.

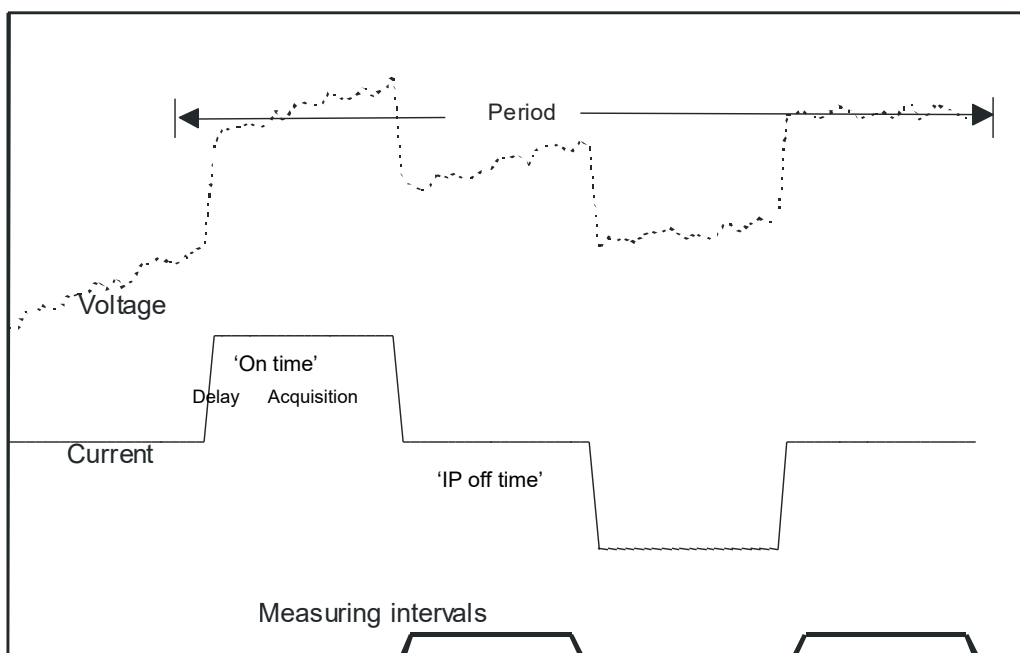

Figure 114 IP measuring cycle timing definitions

9.4 Induced Polarisation (IP): “RES, IP100” Measurement Mode

The ABEM Terrameter LS 2 was the world’s first commercial resistivity meter to incorporate the innovative and efficient 100% duty cycle IP measurement mode. This form of IP measurement removes the ‘off time’ and, instead, extracts the IP effects from the current change-over phases between positive and negative (or negative and positive) current pulses. This provides a larger IP effect to record and faster measurements affording more opportunities to stack the results, all of which results in a better signal to noise ratio.

The following pages present the content of a white paper, written by Guideline Geo, to accompany the launch of the “IP100” feature in 2016.

9.4.1 White Paper Extract: Time-efficient IP Measurements Using 100 % Duty Cycle

The previous ABEM Terrameter LS, as most field resistivity/IP instruments, uses the time domain method to collect IP data. This method has traditionally used what is called a 50 % duty cycle - this means that measurement periods are divided into two equal parts. During the first part, the ON time, current is transmitted into the ground to charge it. During the second part, the OFF time, no current transmission is made, instead the instrument measures how the voltage decays as the ground discharges. During the ON time resistivity data are measured and during the OFF time IP data are measured.

With the current ABEM Terrameters it is possible to measure IP using 100 % duty cycle. This means that there is no OFF time, and that current is always transmitted into the ground. Instead of measuring IP when the ground is discharging, IP will now be measured during the early part of the ON time as the ground is being charged. With this new measure mode both resistivity data and IP data will be measured during the ON time, and the OFF time is not needed. By removing the requirement for an OFF period, it is now possible to measure IP twice as fast as with the traditional IP method.

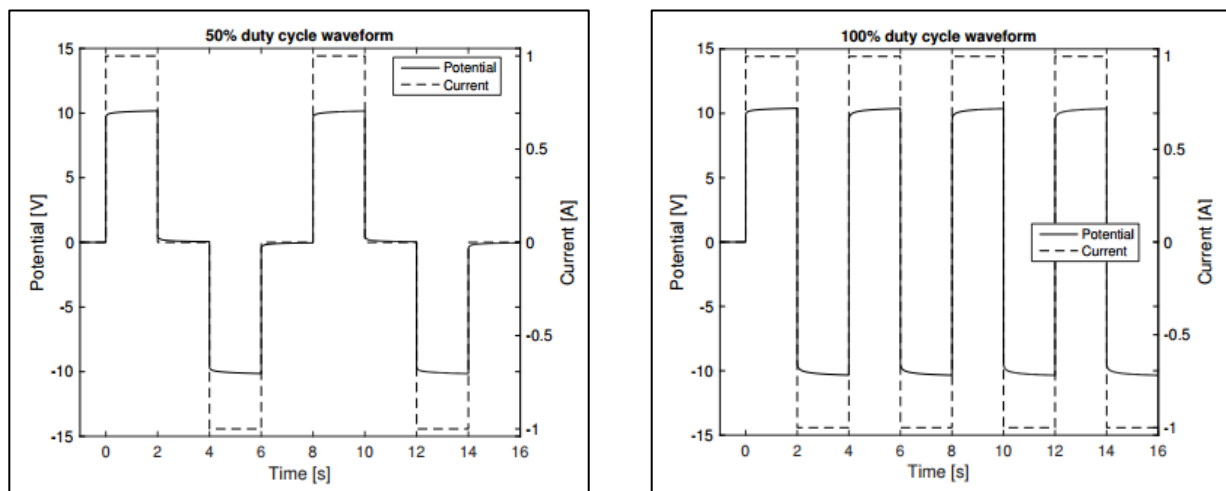

Figure 115 To the left, a 50 % duty cycle measurement using two stacks (repetitions) can be seen. To the right is a 100 % duty cycle measurement using the same ON time as the 50% example but eight pulses can now be measured in the same time that only 4 pulses were achieved with the 50 % duty cycle.

9.4.2 White Paper Extract: Increased Data Quality by Super-positioning the Signal

During resistivity and IP measurements the current transmission polarity is switched in order to remove ground SP (spontaneous potential) effects, which could otherwise cause an offset in recorded voltage values.

For IP using 50 % duty cycle, one cycle will consist of a positive ON time, an OFF time, a negative ON time and an OFF time. It is assumed that the ground has been completely discharged after the OFF time so, after each

polarity switch, the charge-up effect is starting from zero. The voltage values in the IP decay are typically very small and can, in some situations, be difficult to differentiate from background noise.

IP using 100 % duty cycle has no OFF time, and one cycle will consist of a positive ON time, a negative ON time and a positive ON time. This means that at the polarity switch (positive to negative, and negative to positive) the ground will be discharged and charged at the same time. By super-positioning the discharge and charge-up (summing up the two effects) the result is a bigger IP response. With this bigger IP response, the signal to noise ratio (SNR) is increased, producing better data quality as it becomes easier to differentiate the IP decay from the background noise.

9.4.3 White Paper Extract: Exponential SP Background Removal for Increased Accuracy

Uncorrected SP effects can introduce errors in the calculation of resistivity and IP data. For that reason resistivity/IP meters normally use what is called linear SP trend removal. This means that before and after each measurement stack, SP samples are taken and any changes in the SP values can be detected. If the SP value has changed, the SP effect will be removed by using the two SP samples from the start and the end of the measurement cycle to create a linear background trend that is used to estimate the zero level when integrating the results.

The linear SP trend removal works very well if the SP changes are small, or vary at a steady rate. But if the SP changes are non-linear or larger in size, the linear SP trend removal will not be ideal and will result in a difference between the integrated and the actual resistivity/IP value. The measured IP signals are typically very small, and introducing this error in the calculated IP value can have a big effect on the reliability of the final model. In the new IP measure mode an exponential SP trend removal has been implemented. This means that non-linear SP changes can be measured much more precisely and will be incorporated in the resistivity and IP integration for a more accurate result.

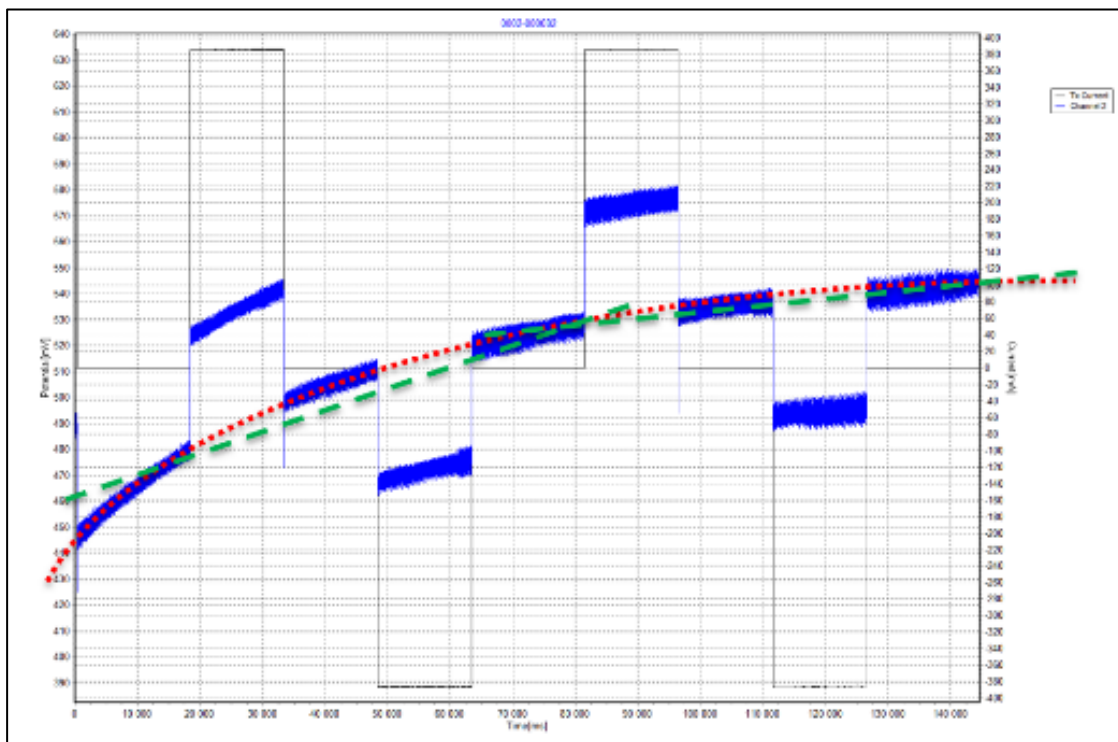

Figure 116 Full waveform data showing (in blue) the measured input voltage, strongly affected by non-linear SP effects. The green dashed line represents how a linear SP trend removal would have worked to estimate the zero level and there is a distinct difference from the actual SP variation and the calculated SP effect, especially in the first part of the measurement. The red dotted line represents an exponential SP trend removal, which produces a much better fit to the actual SP effect

9.4.4 White Paper Extract: Input Channel Filters Optimized for IP

The input channels of the current ABEM Terrameters have been changed in order to give a higher bandwidth for IP data. The new filter design allows for inclusion of more low and high frequency IP components in the calculations than the previous Terrameter LS. This means that the Terrameter LS 2 can start measuring IP decays earlier after current turn off, and that measurements are improved during very long IP times.

9.4.5 White Paper Extract: Additional IP Parameters and Processing Available in Aarhus Workbench

Traditionally IP data have been processed and inverted as an integral IP data set. This means that even if multiple IP windows have been used for increased decay information when measuring, the modelling software will handle the data as if only one, very long, IP window was used. This severely limits the scope for quality evaluation as well as the processing and interpretation possibilities. This 'simplification' of the IP decay may also negatively impact upon the end result in terms of model accuracy.

Using Aarhus Workbench with the ERT/IP modules the full decay data, using all IP windows, will be analysed. This gives a much better view and understanding of the data quality. The IP decay is represented graphically, showing each IP window. In the data processing it is possible to exclude an entire decay curve or, if only parts of the IP decay are affected, individual IP windows can be excluded whilst good segments can still be used.

In all other modelling software for time domain IP data, the IP result can only be represented as chargeability. For frequency domain IP (sometimes called spectral IP) two additional parameters, C and Tau, have been used to fit the IP signal and model the data. These parameters have previously only been available from frequency domain IP data, but Aarhus Workbench is currently the only commercially available software offering this capability for time domain IP data by using Cole-Cole parametrization. Applications for Tau and C values are currently the subject of much research, but potential uses include gaining additional information about the geology, such as grain size and fluid conductivity.

9.4.6 White Paper Extract: Advantages of IP Using 100 % Duty Cycle

The three biggest advantages are:

- Using a 100 % duty cycle, IP data can be collected twice as fast as when using the 'standard' 50 % duty cycle.
- As the signal to noise ratio is twice as high using the new method, IP data quality will be much better than before.
- Exponential SP trend removal makes the IP calculations more accurate.

These are important factors which strengthen the argument that external high power transmitters are not always necessary.

The advantages with Aarhus Workbench ERT/IP for IP data

- Better quality control as the entire IP decay can be seen
- Better processing possibilities as individual sections (IP windows) can be excluded if necessary
- Uses Cole-Cole or Constant Phase Angle analysis for better IP modelling
- Two additional IP parameters, C and Tau (if using Cole-Cole parametrization)

To make full use of the advantages with the new measure mode in the ABEM Terrameter LS 2, Aarhus Workbench is a great tool. The other commercially available inversion software cannot process and model IP data in the same way.

9.4.7 White Paper Extract: References

IP using 100 % duty cycle along with the additional processing are methods and processes that have been developed by Aarhus University and Lund University. The work done by Guideline Geo is to implement parts of the new methods in the ABEM Terrameter LS 2. For more information and research papers we refer to publications of Aarhus University and Lund University.

Olsson, P-I. (2016). *Optimization of time domain induced polarization data acquisition and spectral information content*. Lund

<http://lup.lub.lu.se/record/96ceed10-1a56-4696-8438-06e38e53ce69>

Olsson, P. I., T. Dahlin, G. Fiandaca, and E. Auken. Measuring time-domain spectral induced polarization in the on-time: decreasing acquisition time and increasing signal-to-noise ratio. *Journal of Applied Geophysics*, 2015, 123, 6. 2015.

http://www.hgg.geo.au.dk/ref_manager/OLSSON2015.pdf

Olsson, P-I., Fiandaca, G., Larsen, J. J., Dahlin, T., & Auken, E. (2016). Doubling the spectrum of time-domain induced polarization by harmonic de-noising, drift correction, spike removal, tapered gating, and data uncertainty estimation. *Geophysical Journal International*, 207(2), 774-784. DOI: 10.1093/gji/ggw260

<http://lup.lub.lu.se/record/c787b051-c55c-46e7-bbc1-c1c3feb1fbc8>

For a full list of publications see Aarhus University and Lund University web sites.

10 APPENIX B. SURVEY PROCEDURE FOR COMMON CABLE SETS



The current and voltage transmitted can be life threatening. The red stop button must be engaged while working with connected cables and electrodes. Before starting ANY measurements, ensure survey cables and electrodes are not being handled or touched. Keep all connectors dry and clean. Poor connector handling and maintenance are the main causes of cable failure. Always interconnect removed dust caps to keep them clean and dry during measurements (right).



10.1 Overview of 2-cable, 41 Electrode Layouts (2x21)

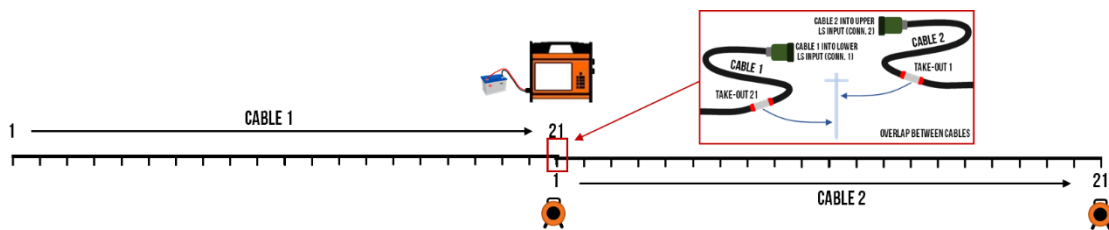

Figure 117 Schematic of a 41 electrode, 2-cable set-up; note the 21 take-out cables use an overlap between cables, where they share a single electrode

10.1.1 Setting-up for 2-cable, 41 Electrode Surveys

- If cables are used at their full take-out spacing, lay out the cables first, overlapping last and first take-outs (only done with 21 take-out cables, see Figure 117), then use the take-outs to position electrodes.
- If an alternative electrode spacing is required, measure a straight line along the ground to position electrodes along the survey profile. Then place Take-out 1 of Cable 1 adjacent to the first electrode in the spread. Walk cable reel 1 along the survey line until all take-outs on the cable are aligned with an electrode.
- Electrodes should be hammered vertically into the ground along to a depth of no more than 1/10th of the electrode spacing.
- Place Take-out 1 of Cable 2 alongside Take-out 21 of Cable 1; the two take-outs will share the same electrode, creating an overlap between cables. When cables are used at their full electrode spacing, this removes the need for a tape measure to position the next cable.
- Take-out numbers should always increase along the profile.
- Finally, place the Terrameter LS 2 and external battery in the middle of the survey line, between Cable 1 and Cable 2.
- Put Cable 1 into Connector 1 and Cable 2 into Connector 2 on the instrument end panel.

Note! If the required electrode spacing is much smaller than the cable take-out spacing, avoid coiling and excessive overlapping of spare cable between the take-outs.

10.1.2 Create Project and Task for a 2-cable, 41 Electrode Surveys

- From the "Welcome" Page, use the <Browse> key to navigate to the "Project List" page (one tab to the right).
- Select <Create New Project>. The "Task List" Page automatically opens.
- Select <Create New Task>. A pop-out window will prompt selections for task settings.
- Spread: Select "2x21".

- Protocol: Choose required electrode array.
- Next, input “Minimum Electrode Spacing X [m]”.
- Select <OK> to exit pop-out window and automatically move to settings.

10.1.3 Start Measurement on a 2-cable, 41 Electrode Survey

- Select <Create New Station (Roll Along)>.
- “Station Position” is the first electrode in the full spread, including any cables that are not in use; the value represents ‘relative electrode position’ rather than distance (i.e. take-out 1 is electrode position 0, take-out 21 is electrode position 20, take-out 41 is electrode position 40). This means that the sequence of “Station Positions” is the same for every survey with a given cable set, independent of spacing. True distance is a product of electrode position and electrode spacing; check that the “Spread extent” values (shown above the table) reflect the correct length of survey line.
- Select “2 cables no move” and exit pop-out window by selecting < OK >.
- Initiate the measurement, noting and accepting all warnings presented.
- When measuring is complete, a “Measuring Done” message will appear in both the “Progress” page and the status bar.
- At this stage it is possible to ‘roll-along’ by returning to the “Create New Station” window and accepting the “1 cable forward” option. On the ground, Cable 1 and all its electrodes should be moved to the far end of Cable 2, and the instrument repositioned in the middle of the new cable spread position (Figure 118 Roll-along on 2x21 cable set).

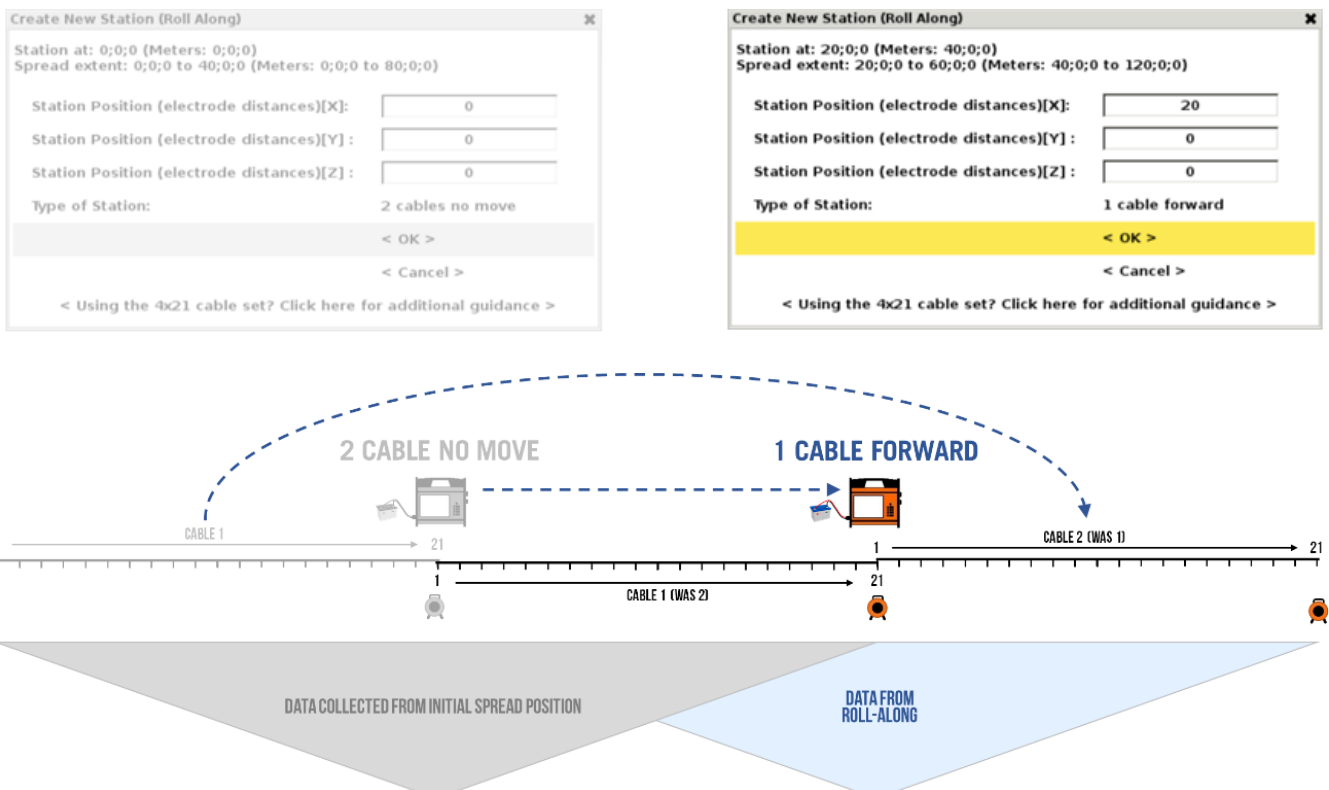

Figure 118 Roll-along on 2x21 cable set

10.2 Overview of 4-cable, 81 Electrode Layouts (4x21)

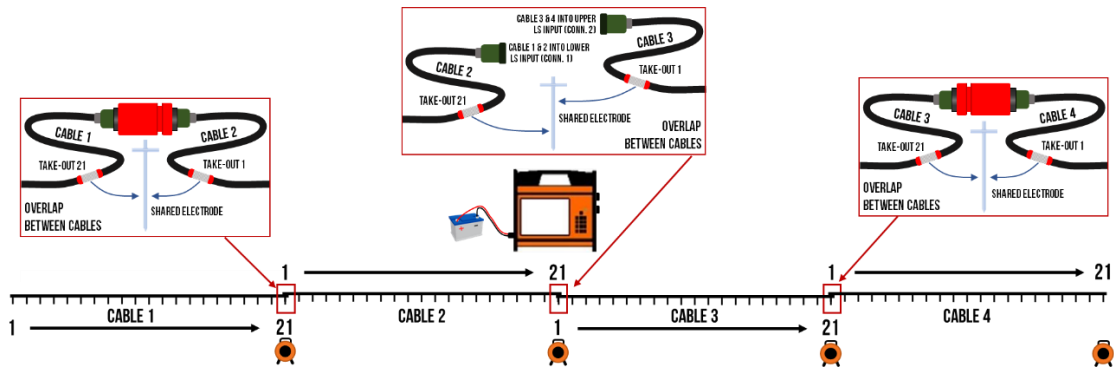

Figure 119 Schematic of an 81 electrode, 4-cable set-up; note the 21 take-out cables use an overlap between cables, where they share a single electrode

10.2.1 Setting-up for 4-cable, 81 Electrode Surveys

- If cables are used at their full take-out spacing, lay out the cables first, overlapping last and first take-outs (only done with 21 take-out cables, see Figure 119), then use the take-outs to position electrodes.
- If an alternative electrode spacing is required, measure a straight line along the ground to position electrodes along the survey profile. Then place Take-out 1 of Cable 1 adjacent to the first electrode in the spread. Walk cable reel 1 along the survey line until all take-outs on the cable are aligned with an electrode.
- Electrodes should be hammered vertically into the ground along to a depth of no more than 1/10th of the electrode spacing.
- Place Take-out 1 of Cable 2 alongside Take-out 21 of Cable 1; the two take-outs will share the same electrode, creating an overlap between cables. When cables are used at their full electrode spacing, this removes the need for a tape measure to position the next cable.
- Take-out numbers should always increase along the profile.
- Place the Terrameter LS 2 and external battery in the middle of the survey line, between Cable 2 and 3.
- Put Cable 2 into Connector 1 and Cable 3 into Connector 2 on the instrument end panel.

Note! If the required electrode spacing is much smaller than the cable take-out spacing, avoid coiling and excessive overlapping of spare cable between the take-outs.

10.2.2 Create Project and Task for a 4-cable, 81 Electrode Survey

- From the “Welcome” Page, use the <Browse> key to navigate to the “Project List” page (one tab to the right).
- Select <Create New Project>. The “Task List” Page automatically opens.
- Select <Create New Task>. A pop-out window will prompt selections for task settings.
- Spread: Select “4x21”.
- Protocol: Choose required electrode array.
- Next, input “Minimum Electrode Spacing X [m]”.
- Select <OK> to exit pop-out window and automatically move to settings.

10.2.3 Start Measurement on a 4-cable, 81 Electrode Survey

The 4x21 (81 electrode) spread is ABEM’s ‘extended’ cable set, used to create a longer spread (and therefore deeper measurements) without adding any additional switching. For a given electrode spacing it improves the maximum theoretical depth by ~25% compared to a regular 64 electrode layout. To achieve this, only the odd-numbered take-outs on Cable 1 and Cable 4 are connected to the switch matrix, which has a maximum capacity for 64 active electrodes. For the deepest measurements, the natural loss of resolution with depth means that

the missing connections do not compromise the final dataset. However, for the near-surface measurements, we want to use the minimum electrode spacing along the whole line. For that reason, the first and last stations of a profile are specifically designed so that an inner cable is used at the very start and end of the survey line (Figure 120).

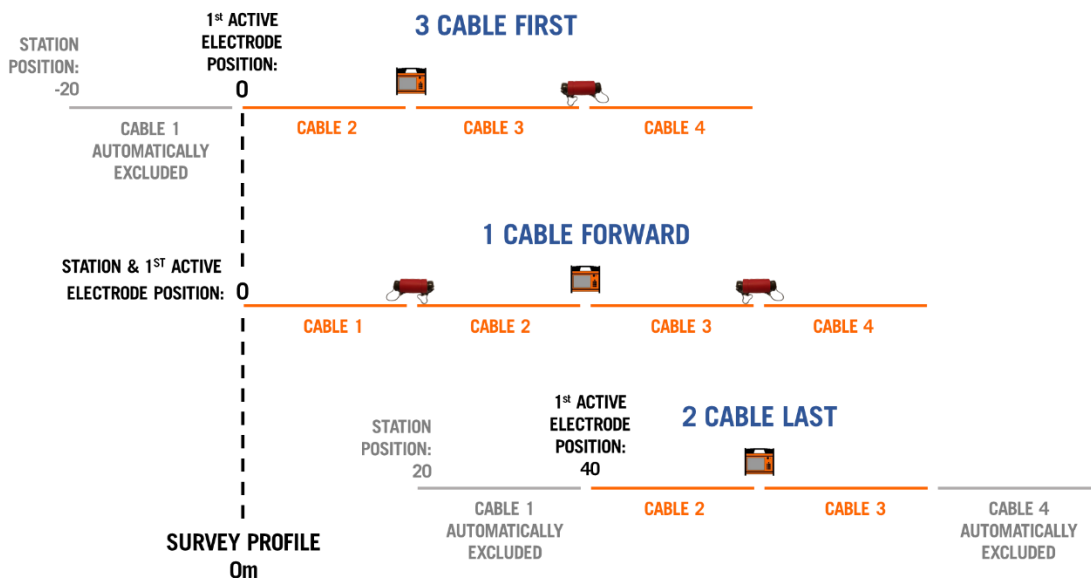
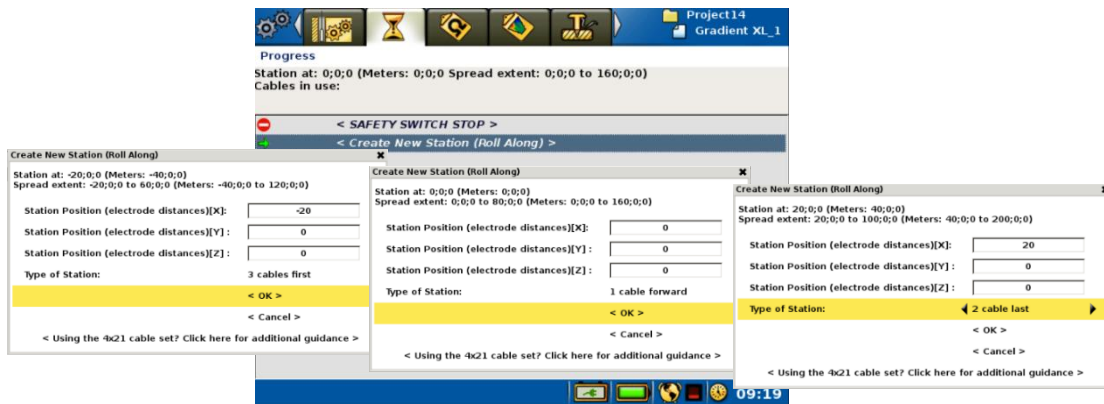

Figure 120 4-cable, 81 take-out survey procedure

- Select < Create New Station (Roll Along) > and a pop-out window will open.
- “Station Position” is the first electrode in the full spread, including any cables that may not be in use, and the value represents ‘relative electrode position’ rather than distance (i.e. take-out 1 is electrode position 0, take-out 81 is electrode position 80). This means that the sequence of “Station Positions” is the same for every survey using a given cable set. True distance is the product of electrode position and electrode spacing; check that the “Spread extent” values (shown above the table) reflect the correct length of survey line.
- Select “3 cables first” and exit the pop-out window by selecting < OK >.
- Initiate the measurement, noting and accepting all warnings presented.
- While the instrument is running through the measurements for this first station, lay out the 4th cable. Do not connect this fourth cable to the rest of the spread while the instrument is actively collecting data; ensure the red stop button is depressed when the connection is made.
- Once data collection is complete at the first position, return to the “Create New Station” window and accept the “1 cable forward” option which is automatically selected. On the ground, move the instrument to the middle of the 4-cable spread.

- During this phase of data collection, watch the “Cables in use” information at the top of the “Progress” tab to identify when Cable 1 can be released for packing away or moving to the next position. Pause the measurement and depress the red stop button whilst disconnecting Cable 1, then resume measurements while you continue to deal with Cable 1.
- **If a roll-along (or more) is required:** position what was Cable 1 at the far end of the spread, and move the instrument forward one cable. Choosing “1 Cable Forward” again from the “Create New Station” dialogue.
- **If roll-along is not required** (or after all roll-along movements are complete): move the instrument one cable forward and select “2 Cable Last” from the “Create New Station” dialogue; this will fill-in the data beneath the last two spread cables.
- Note: If the “3 cable first” and “2 cable last” are not used during a regular survey (first selected station is “4 cables no move” instead), there will be data with half the resolution below the first and last cables of the profile. Every roll-along fills in any missing data from the previous “Cable 4” position, so it is only the first Cable 1 position and final Cable 4 position with the reduced resolution. For some applications, it may not be critical to have the full resolution at one or both ends, so these ‘special’ stations can be skipped. However, using the stations allows field crews to overlap the data collection with both laying out, at the start of the survey, and packing away at the end of the survey.

10.2.4 Measuring With Only Three 21 Take-out Cables

If space is limited and it is only possible to layout 3 cables, the survey procedure is as follows:

- Use the 4x21 spread file and your choice of protocol.
- Place all 3 cables on the ground and connect electrodes, the instrument will sit between the 1st and 2nd cables as if starting a full 4 cable layout.
- Begin measurement using the “3 cable first” station as described above.
- Finish by moving the instrument one cable forward and selecting the “2 cable last” station.

10.3 Overview of 2-cable, 48 and 64 Electrode Layouts (2x24, 2x32)

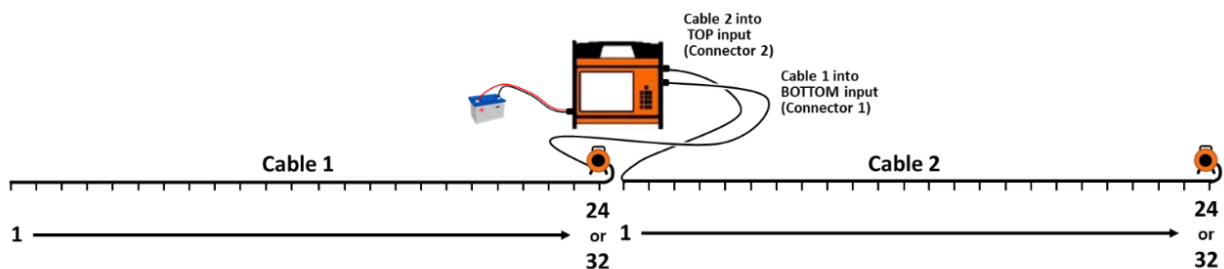

Figure 121 Schematic of a 48 or 64 electrode, 2-cable set-up

10.3.1 Setting-up for 2-cable, 48 or 64 Electrode Surveys

- **If cables are used at their full take-out spacing,** lay out cables first, then use the take-outs to position electrodes.
- **If an alternative electrode spacing is required,** measure a straight line along the ground to position electrodes along the survey profile. Then place Take-out 1 of Cable 1 adjacent to the first electrode in the spread. Walk cable reel 1 along the survey line until all take-outs on the cable are aligned with an electrode.
- Electrodes should be hammered vertically into the ground to a depth of no more than 1/10th of the electrode spacing.

- Next, place Take-out 1 of Cable 2 at the next available electrode or measure the correct spacing for this point. Walk cable reel 2 along the survey line until all cables are out / all take-outs are aligned with an electrode.
- Take-out numbers should always increase along the profile.
- Finally, place the ABEM Terrameter LS 2 instrument and external battery in the middle of the survey line (between Cable 1 and Cable 2).
- Attach Cable 1 into Connector 1 and Cable 2 into Connector 2 on the end panel of the Terrameter LS 2.

Note! If the required electrode spacing is much smaller than the cable take-out spacing, avoid coiling and excessive overlapping of spare cable between the take-outs.

10.3.2 Create Project and Task for 2-cable, 48 or 64 Electrode Surveys

- From the “Welcome” Page, use the <Browse> key to navigate to the “Project List” page (one tab to the right).
- Select <Create New Project>. The “Task List” Page automatically opens.
- Select <Create New Task>. A pop-out window will prompt selections for task settings.
- Spread: Select 2x24 (48 electrode system) or 2x32 (64 electrode system).
- Protocol: Choose required electrode array.
- Next, input “Minimum Electrode Spacing X [m]”.
- Select <OK> to exit pop-out window and automatically move to settings.

10.3.3 Start Measurement on 2-cable, 48 or 64 Electrode Surveys

- Select <Create New Station (Roll Along)>.
- “Station Position” is the first electrode in the full spread, including any cables that may not be in use, and the value represents ‘relative electrode position’ rather than distance (i.e. take-out 1 is electrode position 0, take-out 48 is electrode position 47, take-out 64 is electrode position 63). This means that the sequence of Station Positions is the same for every survey using a given cable set. True distance is the product of electrode position and electrode spacing; check that the “Spread extent” values (shown above the table) reflect the correct length of survey line.
- Select ‘2 cables no move’ and exit pop-out window by selecting < OK >.
- Initiate the measurement, heeding all warnings presented.
- When measuring is complete, a ‘Measuring Done’ message will appear in both the ‘Progress’ page and the status bar.
- At this stage it is possible to ‘roll-along’ by returning to the “Create New Station” window and accepting the “1 cable forward” option. On the ground, Cable 1 and all of the electrodes should be moved to the far end of Cable 2, and the instrument repositioned in the middle of the new cable spread position.

10.4 Overview of 4-cable, 48 and 64 Electrode Layouts (2x24, 2x32)

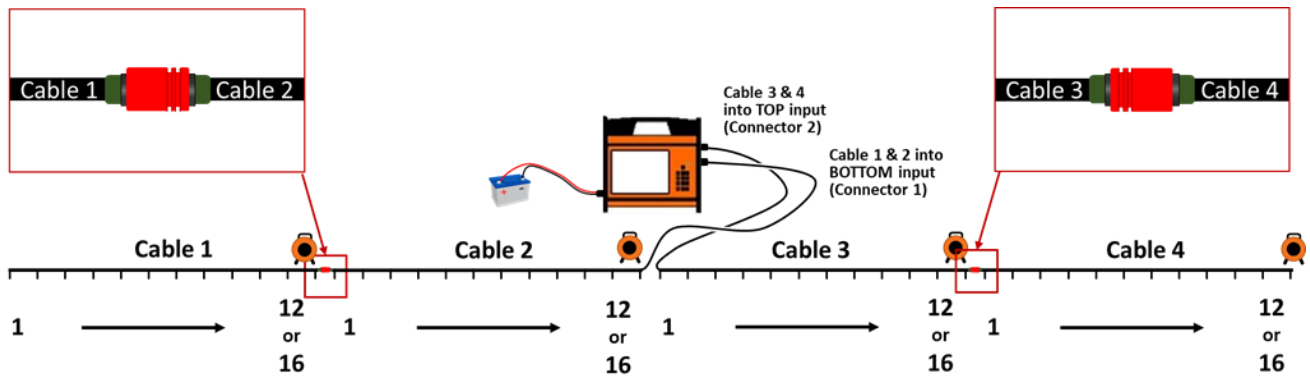

Figure 122 Schematic of a 48 or 64 electrode, 4-cable set-up

10.4.1 Setting-up for 2-cable, 48 or 64 Electrode Surveys

- If cables are used at their full take-out spacing, lay out cables first, then use the take-outs to position electrodes.
- If an alternative electrode spacing is required, measure a straight line along the ground to position electrodes along the survey profile. Then place Take-out 1 of Cable 1 adjacent to the first electrode in the spread. Walk cable reel 1 along the survey line until all take-outs on the cable are aligned with an electrode.
- Electrodes should be hammered vertically into the ground to a depth of no more than 1/10th of the electrode spacing.
- Next, place Take-out 1 of Cable 2 at the next available electrode or measure the correct spacing for this point. Walk cable reels 2 – 4 along the survey line until all cables are out / all take-outs are aligned with an electrode.
- Take-out numbers should always increase along the profile.
- Finally, place the ABEM Terrameter LS 2 instrument and external battery in the middle of the survey line (between Cable 2 and Cable 3).
- Attach Cable 2 into Connector 1 and Cable 3 into Connector 2 on the end panel of the Terrameter LS 2.

Note! If the required electrode spacing is much smaller than the cable take-out spacing, avoid coiling and excessive overlapping of spare cable between the take-outs.

10.4.2 Create Project and Task for 4-cable, 48 or 64 Electrode Surveys

- From the “Welcome” Page, use the <Browse> key to navigate to the “Project List” page (one tab to the right).
- Select <Create New Project>. The “Task List” Page automatically opens.
- Select <Create New Task>. A pop-out window will prompt selections for task settings.
- Spread: Select 4x12 (48 electrode system) or 4x16 (64 electrode system).
- Protocol: Choose required electrode array.
- Next, input “Minimum Electrode Spacing X [m]”.
- Select <OK> to exit pop-out window and automatically move to settings.

10.4.3 Start a Measurement on 4-cable, 48 or 64 Electrode Surveys

- Select <Create New Station (Roll Along)>.
- “Station Position” is the first electrode in the full spread, including any cables that may not be in use, and the value represents ‘relative electrode position’ rather than distance (i.e. take-out 1 is electrode position 0, take-out 48 is electrode position 47, take-out 64 is electrode position 63). This means that the sequence of Station Positions is the same for every survey using a given cable set. True distance is

the product of electrode position and electrode spacing; check that the “Spread extent” values (shown above the table) reflect the correct length of survey line.

- Select ‘4 cables no move’ and exit pop-out window by selecting < OK >.
- Initiate the measurement, heeding all warnings presented.
- When measuring is complete, a ‘Measuring Done’ message will appear in both the ‘Progress’ page and the status bar.
- At this stage it is possible to ‘roll-along’ by returning to the “Create New Station” window and accepting the “1 cable forward” option. On the ground, Cable 1 and all of the electrodes should be moved to the far end of Cable 4, and the instrument repositioned in the middle of the new cable spread position.

11 APPENDIX C. SPREAD AND MEASURING SEQUENCE FILES

11.1 General

The measurement process is controlled via spread description files and protocol (measuring sequence) files. A protocol file must always refer to a spread description file and, in some cases, a protocol file may be compatible with (and therefore reference) multiple different spread description files.

The same protocol files can be used for instruments with different numbers of available channels, so that the same protocol can be used for an instrument with 2, 4, 8, 10 or 12 channels. It may, however, be possible that protocol files using different strategies for optimising the use of the channels are most suited for the different versions of the instrument.

Spread and protocol files are in XML format and consequently will have an XML filename extension. XML is a text-based code that allows for simple structuring of data and information. It utilises ‘flags’ to group information together, with an opening flag <xxxxx> and a closing flag </xxxxx> at either end of the information string, where “xxxxx” can be anything provided it matches between the opening and closing flags. Flag pairs can be nested *within* other flagged data to group together different strings of information which share something in common. To see this in the context of the Terrameter spread and protocol files see Chapter 11.2 *Spread Description Files in XML-format*.

For older versions of the ABEM Lund Imaging System the spread description files are called address files (ADR filename extension). Separate files were used for the first measurement station (.ORG) and following stations in the roll-along procedure (.UP and .DWN) but that is not needed for Terrameter LS 2. A utility that converts from the old to the current system is available in Terrameter LS Toolbox (“Protocols / Convert ADR to XML Spread File” and “Protocols / Convert ORG to XML Protocol File” respectively).

There are numerous programs available for editing XML files. A basic text editor such, as Microsoft Notepad is sufficient but using a dedicated XML editor is recommended. There are several dedicated XML editors available on the market and one free alternative is XML Marker. It can be downloaded from www.symbolclick.com

A list of common measuring sequence and protocol files can be found in Chapter 11.1.2 *Typical Measuring Sequence Files*.

11.1.1 Typical Spread Files

A number of standard spread files are supplied with the Terrameter LS 2. It should be noted that additional files can be added from a ‘library’ installed with Terrameter LS Toolbox. This software is also the easiest way to add custom spread files.

Name	Description
VES C1C2P1P2	Uses the individual connectors on the end panel for VES or other basic 4-electrode measurements.
2x21	Set of 2 electrode cables with 21 take-outs each, and a 1 take-out overlap between the two cables.
2x24	Set of 2 electrode cables with 24 take-outs each, both laid in the same direction (i.e. take-out numbers always increasing along profile), and no take-out overlap.
2x32 increasing	Set of 2 electrode cables with 32 take-outs each, both laid in the same direction (i.e. take-out numbers always increasing along profile), and no take-out overlap.

2x32 mirrored	Set of 2 electrode cables with 32 take-outs each, laid in opposite directions (with the low-numbered take-outs closest to the instrument), and no take-out overlap.
4x12	Set of 4 electrode cables with 12 take-outs each, all laid in the same direction (i.e. take-out numbers always increasing along profile), and no take-out overlap.
4x16	Set of 4 electrode cables with 16 take-outs each, all laid in the same direction (i.e. take-out numbers always increasing along profile), and no take-out overlap.
4x21	Set of 4 electrode cables with 21 take-outs each, all laid in the same direction (i.e. take-out numbers always increasing along profile), and a 1 take-out overlap between the cables.

11.1.2 Typical Measuring Sequence Files

A number of standard measuring sequence (protocol) files are supplied with all Terrameter LS 2 spread files. It should be noted that additional files can be added from a 'library' installed with Terrameter LS Toolbox. This software is also the easiest way to add custom spread files.

Name	Description
Gradient	Guideline Geo recommends using multiple gradient for most 2D ERT work; provides a good compromise between the other protocol characteristics. It has good signal-to-noise ratio, is multi-channel compatible, and provides good definition of horizontal and vertical structures.
Dipole-dipole	Excellent for targeting vertical or laterally-confined features, but not so good at defining horizontal layering. Poor signal-to-noise ratio, means this protocol can be problematic in electrically 'noisy' environments or if targeting particularly deep targets. Separation of C1C2 and P1P2 make it attractive for IP. Rapid for ERT as it is a multi-channel compatible array.
Schlumberger	Excellent for delimiting broad, horizontal layers not so good at defining limits of vertical or laterally confined features. Second only to Wenner for signal-to-noise ratio, so can also be useful when targeting particularly deep features. Very slow for ERT as this is a single-channel array (i.e. only one data point collected per current injection).
Wenner	Excellent for delimiting broad, horizontal layers not so good at defining limits of vertical or laterally confined features. Best signal-to-noise ratio, so can also be useful when targeting particularly deep features. In VES surveys, requires more work as all 4 electrodes must be moved every time. Very slow for ERT as this is a single-channel array (i.e. only one data point collected per current injection).
Pole-dipole/Pole-pole	Both of these array types offer attractive spread length-to-depth ratios; in other words, you can image much deeper with a particular spread of electrodes. However, they require remote electrodes (one for pole-dipole and two for pole-pole), and these must be positioned at a great distance from the spread (~20 times the largest current-potential probe separation) which makes them impractical in many scenarios. They can be useful for 3D measurements where the spread of electrodes may be quite limited.

11.1.3 Standard Test and Diagnostic Protocols

A number of standard test and diagnostic protocols are supplied with Terrameter LS 2. The following files are included (see Chapter 8 *Testing, Diagnostics and Fault Finding* for test details):

Spread	Protocol(s)
LS Internal	Selftest
Cable Test	Continuity Test, Isolation Test, x12 Cable Joint Test, x16 Cable Joint Test, x21 Cable Joint Test
VES C1C2P1P2	Simple RES

11.2 Spread Description Files in XML-format

The spread description files define the hardware configuration for a measurement. A spread description file can be as simple as specifying how the C1, C2, P1 and P2 terminals on the end panel are connected to the internal receiver and transmitter or it can be more complex and include parameters such as number of electrode cables, number of electrode take-outs per cable, and roll-along direction and step size. It also contains the necessary details on the wiring between electrode take-outs and the physical relay switch channels (which equate to pins on the connectors).

The files are relatively self-explanatory, since XML-format is used but, in brief:

- <Cable> ... </Cable> defines details of one electrode cable and definitions of all electrodes (see below) belonging to that cable must be defined within the same <Cable> section.
- <Id> ... </Id> is the electrode number that the protocol files will refer to when selecting electrodes.
- <X> ... </X> refers to the position of the electrode along the spread in terms of number of electrode spacing steps (relative electrode spacing).
- <Name> </Name> is the text used to describe the electrode in, for example, the electrode contact test and in the table of results.
- <SwitchAddress> ... </SwitchAddress> defines how the electrode is connected to the relay switch; in other words, which pin on the end panel.
- <SwitchId> ... </SwitchId> specifies whether the internal relay switch is used or which of the external switches (ES10-64C units) is required. The default is "0" which refers to the internal relay switch, and this is assumed if this string is not present.

The initial part of a 2x32 spread file, as far as the second electrode, is shown below:

```
<?xml version="1.0" encoding="UTF-8" ?>
<Spread>
  <Name> 2x32 </Name>
  <Description> Spread of 2x32 take-out cables (no electrode overlap) </Description>

  <CreateStation>
    <Name> 2 cables no move </Name>
    <X> 0 </X>
  </CreateStation>

  <CreateStation>
    <Name> 1 cable forward </Name>
    <X> 32 </X>
  </CreateStation>
```

```

<CreateStation>
  <Name> 1 cable backwards </Name>
  <X> -32 </X>
</CreateStation>

<Rollalong> // Kept for compatibility with older versions of Terrameter instrument software
  <X> 32 </X>
  <Y> 0 </Y>
</Rollalong>

<Cable>
  <Name> 1 </Name>
  <Electrode>
    <Id> 1 </Id>
    <X> 0 </X>
    <Name> 1-1 </Name>
    <SwitchAddress> 1 </SwitchAddress>
  </Electrode>
  <Electrode>
    <Id> 2 </Id>
    <X> 1 </X>
    <Name> 1-2 </Name>
    <SwitchAddress> 2 </SwitchAddress>
  </Electrode>

```

If an external relay switch (ES10-64C) is used, the spread description must also define this by adding the SwitchId as shown in this example:

```

<Cable>
  <Name> 5 </Name>
  <Electrode>
    <Id> 65 </Id>
    <X> 64 </X>
    <Name> 5-1 </Name>
    <SwitchId> 2 </SwitchId>
    <SwitchAddress> 1 </SwitchAddress>
  </Electrode>

```

A <SwitchId> must be specified for each electrode that is controlled by the internal switch. ES10-64C units will be numbered sequentially from <SwitchId> 2 onwards. On the first ES10-64C the <SwitchAddress> resets to 1, but these numbers then increase sequentially through all subsequent ES10-64C units.

11.2.1 Spread Files for Pole-dipole and Pole-Pole

It is important that the spread file references the remote electrodes that are in use with pole-dipole and pole-pole layouts. These will almost certainly be connected to the individual current and potential connectors on the end panel of the instrument.

Below is an extract from part of a pole-dipole spread file, which references the remote current electrode:

```

<Cable>
  <!-- Add remote electrodes -->
  <Name> LS Panel </Name>
  <Electrode>
    <Id> 102 </Id>
    <Name> C2 Current </Name>
    <SwitchId> 0 </SwitchId>
    <SwitchAddress> 2</SwitchAddress>
  </Electrode>
</Cable>

```

For pole-pole measurements, two remote electrodes (one current, one potential) must be specified in the spread file:

```
<Cable>
  <!-- Add remote electrodes -->
  <Name> LS Panel </Name>
  <Electrode>
    <Id> 102 </Id>
    <Name> C2 Current </Name>
    <SwitchId> 0 </SwitchId>
    <SwitchAddress> 2</SwitchAddress>
  </Electrode>
  <Electrode>
    <Id> 104 </Id>
    <Name> P2 Potential </Name>
    <SwitchId> 0 </SwitchId>
    <SwitchAddress> 4</SwitchAddress>
  </Electrode>
</Cable>
```

The <Id> for C2 and P2 (in this case 102 and 104) can be selected arbitrarily, provided they do not already exist elsewhere in the spread. In the associated protocol, “0” can be used as the electrode number for these. In cases where the system is paired with additional electrode selectors (ES10-64C), there will be real electrodes with <Id> 101, 102, 103, 104, so then other arbitrary <Id> numbers, for example 501 to 504, can be used for remote electrodes. It is only important to have a unique <Id> for each electrode; the software uses the <SwitchId> and <SwitchAddress> to ‘find’ the remote electrodes.

11.3 Protocol Files in XML-format

The protocol files describe the type of electrode array(s) in use, the measuring sequence, and can be designed to do measurements using arbitrary arrays. A protocol file always refers to at least one spread description file, which simplifies the protocol files immensely, since each electrode only needs to be referred to by the number assigned to it within the <Name> flag of the spread description file. Protocol flags are as follows:

- <SpreadFile> </SpreadFile> specifies the associated spread description file(s). If there is more than one compatible spread file, this statement is repeated.
- <Sequence> </Sequence> marks start and end of the measuring sequence (i.e. the list of electrode pairs for current and voltage).
- <Measure> </Measure> defines a measurement, or set of measurements, using one current electrode pair.
- <Tx> </Tx> specifies electrodes to be used for current during a measurement.
- <Rx> </Rx> specifies all potential electrodes used for measurement during a current injection defined by the <Tx> flag. There can be an unlimited number of potential electrode pairs for a single current electrode pair; the instrument will repeat current injections until the required measurements have all been taken.

The initial section of a protocol file will look similar to the following example:

```
<Protocol>
  <Name> Wenner </Name>
  <Description> Wenner measuring on spread with 64 electrodes </Description>

  <Arraycode> 1 </Arraycode>
  <SpreadFile> 4X16.xml </SpreadFile>
  <SpreadFile> 2X32increasing.xml </SpreadFile>
  <SpreadFile> 2X32mirrored.xml </SpreadFile>
```

```

<Sequence>
  <Measure>
    <Tx> 1 64 </Tx>
    <Rx>
      22 43
    </Rx>
  </Measure>
  <Measure>
    <Tx> 1 61 </Tx>
    <Rx>
      21 41
    </Rx>
  </Measure>

```

The previous example shows a normal Wenner array, for which it is not possible to utilise the multi-channel measuring capability – due to the geometry required by Wenner, only one voltage measurement can be made for a given current pair.

Conversely, the multiple gradient array can take advantage of efficient, multi-channel measuring, and the <Measure> section may look like the example below:

```

<Measure>
  <Tx> 1 61 </Tx>
  <Rx> 7 13 </Rx>
  <Rx> 19 25 </Rx>
  <Rx> 31 37 </Rx>
  <Rx> 43 49 </Rx>
  <Rx> 13 19 </Rx>
  <Rx> 25 31 </Rx>
  <Rx> 37 43 </Rx>
  <Rx> 49 55 </Rx>
</Measure>

```

Note that the number of measuring channels activated on an instrument does not restrict the number of <Rx> pairs that can be associated with a single <Tx> pair. The same measurement sequence file (protocol) can be used on any instrument, regardless of the number of available channels.

11.3.1 Protocol Files for Pole-dipole

Pole-dipole measurements use a remote electrode connected to the end panel of the Terrameter. A single <Measure> entry in a Pole-dipole protocol may look as follows:

```

<Measure>
  <Tx> 23 0 </Tx>
  <Rx> 22 21 </Rx>
</Measure>

```

The <Tx> 23 0 </Tx> line instructs the software to translate the reference to electrode id 0 to the "C2 Current" electrode. The software will look for the electrode with switchid=0 and switchaddress=2. The id of the remote electrode (for instance102) must be unique within the spread and not 0.

11.3.2 Protocol Files for Pole-pole

Example of protocol file

```

<Measure>
  <Tx> 1 0 </Tx>
  <Rx> 49 0 </Rx>
</Measure>

```

The "<Tx> 1 0 </Tx>" line will tell the software to translate the reference to electrode id 0 to the "C2 Current" electrode, and <Rx> 49 0 will tell the software to translate the reference to electrode id 0 to the "P2 Potential" electrode.

11.3.3 Optimising the Use of Channels for Pole-pole

While it is possible to make pole-pole measurements with the Terrameter LS 2 without any special accessories, using a special device can optimise the use of measuring channels. The interconnections of all channels “P2” to the remote potential electrode can be done via an adapter connected to the external connector AUX or the connector Interconnect. The wiring of the adapter should connect the pins C, X, Z and b in the KPT32 connector AUX². This will interconnect every second row of the switch and the remote potential electrode will be possible to route to all receiver channels. It is the same wiring for 4, 8 or 12 channel systems. The signals are also available in the Interconnect connector pin N, R, T and V in the KPT19 connector, so the wiring could be done there as an alternative.

An additional option in the spread file sets the pole mode for the spread. It is only needed if you connect an adapter that modifies the wiring of the instrument.

```
<PoleMode>
  P2Half
</PoleMode>
```

This tells the software that a special hardware device is attached that will connect half of the rows (4, 6, 8, 10) of the switch to the P2 remote electrode. It is only the external part of the switch that will be affected. Valid options are:

- NoPol - No remote pole electrodes
- P1, - P1 is in use. This is automatic if P1 is defined in spread
- P2, - P2 is in use. This is automatic if P2 is defined in spread
- P1P2, - P1 and P2 are in use. This is automatic if P1 and P2 is defined in spread
- P1Half, Connect P1 to half of the rows in the switch 3, 5, 7, 9
- P2Half, Connect P2 to half of the rows in the switch 4, 6, 8, 10
- P1P2Half, Connect P1 to 3, 5, 7, 9 and Connect P2 to 4, 6, 8, 10
- P1All, Connect P1 to row 3-10. (This will only shortcut the outside P1 and P2 connectors)
- P2All, Connect P2 to row 3-10 (This will only shortcut the outside P1 and P2 connectors)

11.4 Protocol Files in XML-format for VES

Manual movement of electrodes can be used for measuring with geometries not compatible with electrodes cables designed for standard 2D and 3D multi-electrode surveying. Each movement of electrodes must then be done manually according to the positions defined in the protocol file. One measurement point is defined by a set of descriptions <Select> and <Move> flags:

```
<Select> MN/2= 0.2 AB/2= 1
  <Move> 1 <X> 1 </X> </Move>
  <Move> 2 <X> -1 </X> </Move>
  <Move> 3 <X> 0.2 </X> </Move>
  <Move> 4 <X> -0.2 </X> </Move>
</Select>
```

The text immediately after the <Select> flag will be displayed on the instrument *Screen*, and the <Move> flags define the electrode coordinates used for calculating the electrode positions in the data file. The entire statement above can be written on one line if preferred.

² The cable intended for pole-pole measurement with SAS4000 and ES464 (part no. 33 0020 14) will work on a Terrameter LS / LS 2. if connected to AUX (the other end of the cable should not be connected).

The electrodes are connected via cables to C1, C2, P1 and P2 connectors on the contact panel. This is defined in the following statement:

```
<Sequence>
  <Measure>
    <Tx> 1 2 </Tx>
    <Rx> 3 4 </Rx>
  </Measure>
</Sequence>
```

11.5 Legacy Formats

11.5.1 Cable Description Files in ADR-format

The address files (cable description files - extension .ADR) are the equivalent of the spread files in the system used by older versions of the ABEM Lund Imaging System. It contains information about the physical configuration of the measuring channels in relation to connections and cables presently used, and includes for instance number of electrode cables, number electrode take-outs per section, internal and external addresses of electrode channels, etc. All parameters are integers. Since one way of creating a spread file for Terrameter LS 2 is to convert from and ADR-file the format is given as reference here.

The following format is used in the files:

n_{sec} n_{each}	{ number of electrode cables, total number of take-outs per cable }
n_{skip} n_{x-move} [n_{y-move}]	{ active electrode skip factor, lengths for x-move, lengths for y-move }
n_{tot} [n_x]	{ total no of active take-outs, no of take-outs in x-direction }
1 adr_1 $cable_1-pos_1$	{ number, internal address and physical position of 1st take-out }
2 adr_2 $cable_2-pos_2$	{ number, internal address and physical position of 2nd take-out }
...	
...	
n_{tot} $adr_{n_{tot}}$ $cable_{n_{tot}}-pos_{n_{tot}}$	{ number, internal address and physical position of last take-out }

For line oriented cable arrangements with roll-along in the direction of the cable the parameters n_{y-move} and n_x are not specified, but only for area cover and 3D cable arrangements. In these cases the parameter n_{x-move} is set to zero. Excluded electrode positions can be entered into the address file by assigning the address 0 (zero). These electrode positions will then be omitted from electrode contact test and measuring.

Note that the pins 22-32 in the standard cables with 21 take-outs each are not connected to any electrode take-outs, but used for linking every second take-out on the outer electrode cables to the Terrameter / Electrode Selector via the cable joints.

11.5.2 Protocol Files in ORG-format

The format of protocol files in the system used by older versions of the ABEM Lund Imaging System is presented here for reference since one way of creating an XML-format protocol file is to convert from this format. The first station (midpoint position) is always measured using a protocol file with .ORG filename extension. Consecutive stations use .UP or .DWN protocol files depending on if the roll-along is done towards higher or lower

coordinates. The .UP or .DWN files are reduced according to the possible data overlap with the previous station, to avoid measuring the same data points twice. This also means that measuring is normally much faster for consecutive stations at a roll-along than for the first. Terrameter LS 2 automatically reduces the measurements at consecutive stations for overlap with measurements already taken at previous stations, so it is only necessary to convert the ORG-file

If more than one protocol file is used for each station there is also a possible overlap, between the protocol files at the same midpoint, as for example when doing Wenner CVES with long and short layouts. In this case one of the files should be reduced accordingly.

The protocol files contain an array code, the address file used followed by a comment string, and the logical positions of the electrodes. The positions are given for the current electrodes followed by the position of the potential electrodes. The format is thus:

```
code                [arraystring]
addressfile         [commentstring]

Apos(1) Bpos(1) Mpos(1) Npos(1)
Apos(2) Bpos(2) Mpos(2) Npos(2)
...
...
Apos(n) Bpos(n) Mpos(n) Npos(n)
```

where the electrode positions are given as integers in the interval 1- n_{tot} . If remote electrodes are used these positions are specified as zero.

The array codes are used mainly for presentation purposes, and in the case of pole-pole and pole-dipole how the contact test is performed. The array codes used for Terrameter LS 2 are compatible with Res2dinv, and they differ from what is used by Terrameter SAS1000 / SAS4000. The following codes are defined:

Electrode Array	Array Code	Code in <i>Old System</i>
Resistance	0	0
Wenner- α	1	1
Pole-Pole	2	4
Dipole-dipole	3	5
Pole-dipole	6	6
Schlumberger	7	10
Equatorial dipole-dipole	8	13
General surface array	11	11
Tomography	12	12
Potential	14	14
Multiple gradient array	15	15

If an array not defined in the list is to be used, array code 11 for general surface array may be used. Alternatively array code 0 for resistance can be used, which means that resistance instead of apparent resistivity is displayed during measurement. If array code 12 is used only the electrode numbers, and not the coordinates are saved, which is suitable for instance measurements involving boreholes (see Chapter 11.5.3 *Geometry Files*, below).

11.5.3 Geometry Files

The electrode coordinates for a borehole measurement are entered via a geometry file (text file with XYZ file extension), with the following format:

n-cables

Header cable 1

1	X _{1,1}	Y _{1,1}	Z _{1,1}
2	X _{1,2}	Y _{1,2}	Z _{1,2}
...			
n ₁	X _{1,n1}	Y _{1,n1}	Z _{1,n1}

Header cable 2

1	X _{2,1}	Y _{2,1}	Z _{2,1}
2	X _{2,2}	Y _{2,2}	Z _{2,2}
...			
n ₂	X _{2,n2}	Y _{2,n2}	Z _{2,n2}

Header cable 3

1	X _{3,1}	Y _{3,1}	Z _{3,1}
2	X _{3,2}	Y _{3,2}	Z _{3,2}
...			
n ₃	X _{3,n3}	Y _{3,n3}	Z _{3,n3}

12 APPENDIX D. TERRAMETER LS TOOLBOX OVERVIEW

12.1 General

Terrameter LS Toolbox is the free auxiliary software for the Terrameter LS 2. It contains utilities for downloading, filtering and exporting data ready for inversion, transferring spreads and protocols, updating instrument software/firmware, and editing date, time and time zone settings. This appendix is a very brief overview of functionality, for full instructions consult the Terrameter LS Toolbox user manual.

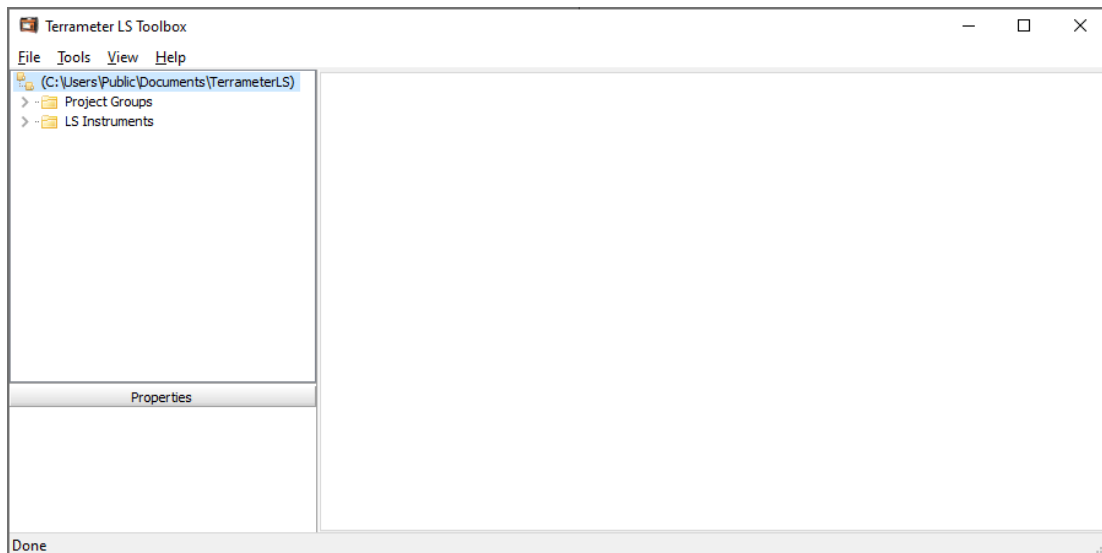

Figure 123 Terrameter LS Toolbox main window

12.2 Connecting to the instrument

Select one of the following option from the “Network” Page of the Terrameter LS 2 (see Chapter 4.2 4.2Network Connections for more information):

- Wifi Access Point (no physical connection required)
- LAN Server (connect direct to PC with an Ethernet cable)
- LAN Client (connect the Terrameter to the same local network as your PC via an Ethernet cable)

Right-click with a mouse on the “LS Instruments” folder (upper-left window) and choose “Connect”. When connected, a small coloured instrument icon will appear with the serial number next to it. When not connected the icon will turn grey and the only other option available from the right-click menu is “Remove” which will delete the selected Terrameter from the list of ‘remembered’ instruments.

12.3 Working with a connected instrument

Once the instrument is connected, right-click on the coloured instrument icon to open the actions menu again. More options will be activated now that the connection an instrument been established.

12.3.1 Disconnect

This option drops the link to the Terrameter LS 2 and the icon will grey-out.

12.3.2 Manage Projects

Select this option to download data from the instrument. The download window (Figure 124) will automatically load in the list of projects on the instrument and provide information on the database size and whether or not the projects contain full waveform data. The size of the full waveform folder is only read on demand as it can be quite slow to calculate; right-click on a project to request this information.

A “Start Destination” can be defined and all projects will be automatically saved to this location if the relevant tick-box is selected beneath it. If the tick-box is left blank, every project downloaded will request a separate save location but the “Start Destination” will be where the file explorer window defaults to when it opens.

It is not necessary to download full waveform data, it is possible to take just the database file which allows all regular quality assurance and filtering procedures to be undertaken. A tick-box defines whether the full waveform will be included in the download. The project database will download first, followed by the full waveform files after.

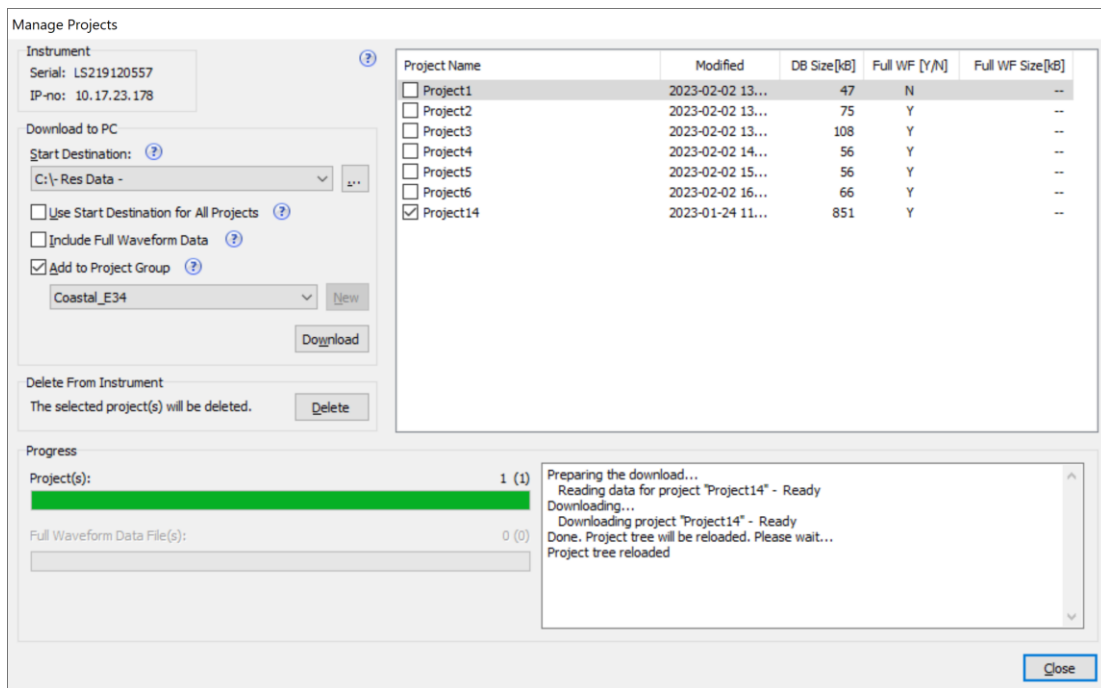

Figure 124 Manage Projects dialog for downloading data

The downloaded projects can be added to a project group (see 12.4 Working with data) to aid administration of survey data. It is necessary to create the project group before downloading.

12.3.3 Set timezone and time

This menu allows for configuration of the onboard clock including the option to quickly sync the time with the PC used for the connection.

12.3.4 Import/Export Spread and Protocol

Transfer spreads and protocols to the instrument from this window (Figure 125); the left side shows the spread and protocol files on your PC and the right window shows the spreads and protocols on the instrument.

In the left window select the spread and protocol files that you want to have on the instrument and select “To Instrument”. Ensure the “Allow overwrite” box is ticked beneath the right-hand window.

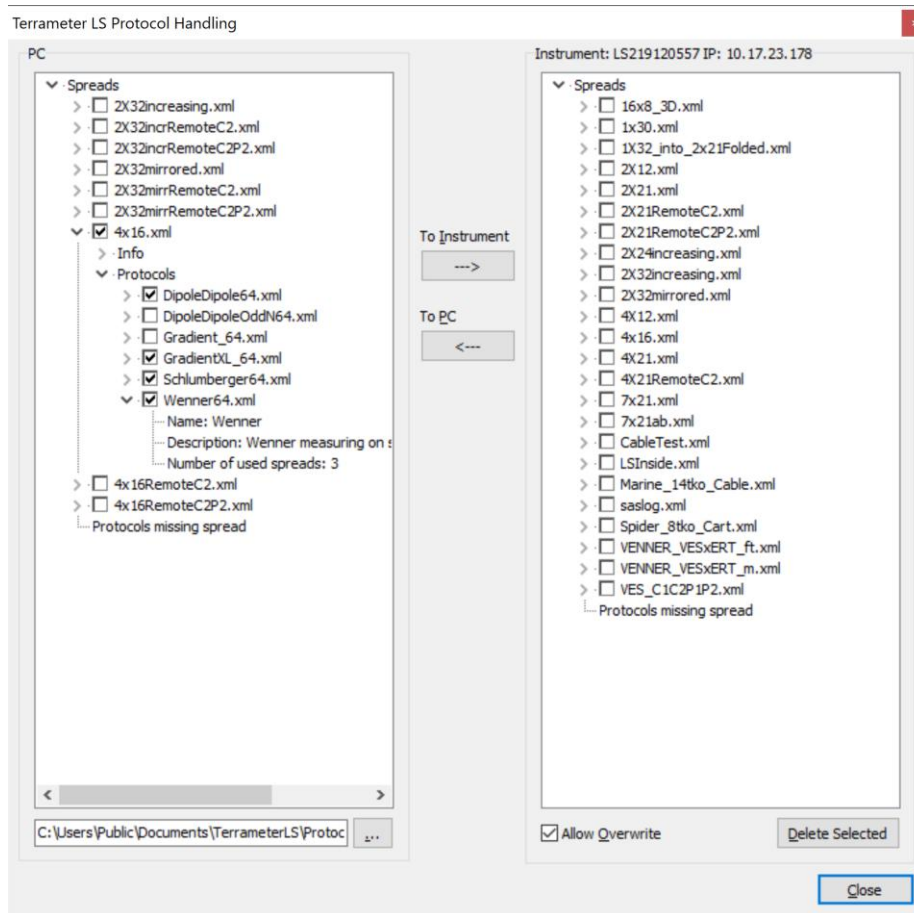

Figure 125 The spread and protocol transfer window

Note! Spread files have all compatible protocols listed beneath them; click on the “>” next to the spread to see the protocols beneath it. The software does not automatically select the protocols when you select the spread file, so you must click the box next to all spreads AND all protocols that you want to transfer.

12.3.5 Update

This window allows updates of the Terrameter instrument software to be made and also installation of pre-loaded settings files. The necessary files can be downloaded from the Guideline Geo website and stored on the local computer or network that the Terrameter LS 2 is connected to.

The “Update” window contains instructions on how to install the new files onto the Terrameter LS 2.

12.3.6 Enable TX Updating

The transmitter (TX) firmware updates are slightly more complex than the instrument software updates; however, full instructions will come alongside the necessary files when they are downloaded from the Guideline Geo website.

12.4 Working with data

Once data has been added to LS Toolbox (either by downloading from an instrument or by importing a stored project database) the “Project Groups” section expands to form a data tree, which allows the user to organize and interrogate projects and tasks. Figure 126.

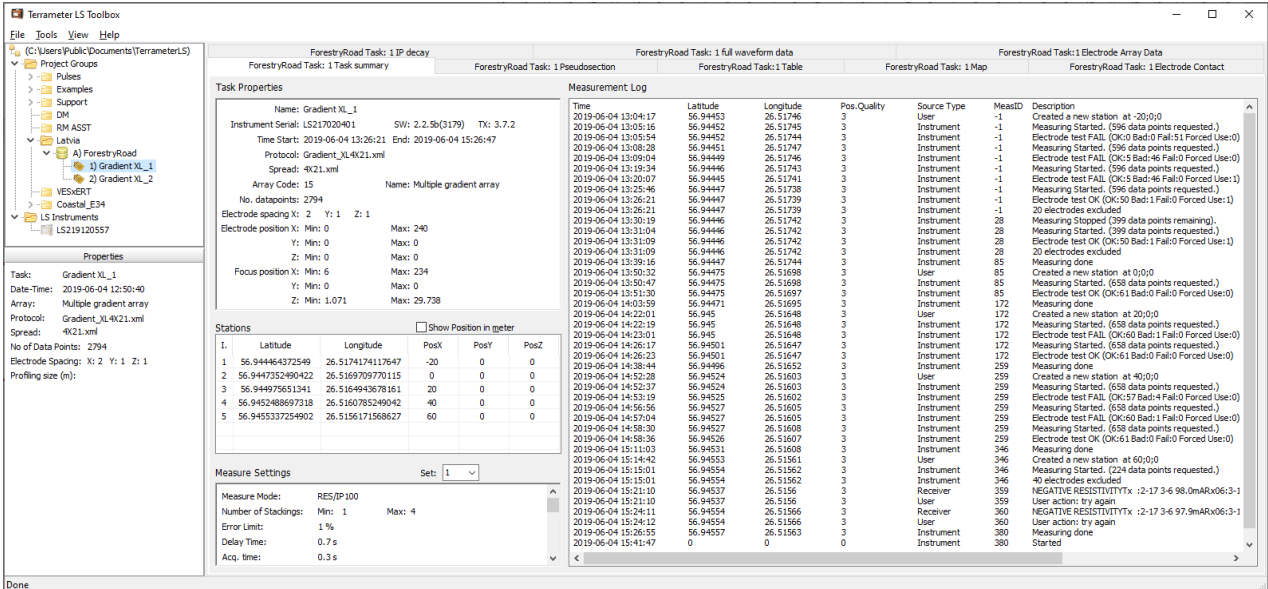

Figure 126 LS Toolbox main window with data tabs opened for a particular task

On first use of the software there will be no ‘branches’ in the data tree so it is necessary to right-click on “Project Groups” and select “Create Project Group”. Once this has been done, data can be downloaded directly to that project group or imported by selecting “Add Project” from the right-click menu associated with each project group (see left-hand example in Figure 127).

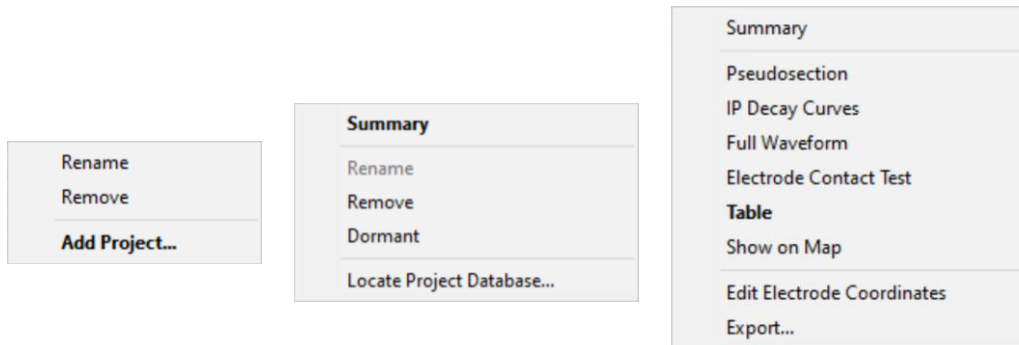

Figure 127 Right-click menus for (L-R): a project group, a project and a task

Note! The “Locate Project Database” option on the right-click menu for projects is a quick way to find the project.db file for a particular measurement; Guideline Geo support technicians may ask for a copy of this file, for diagnostic purposes, if you have a problem with data or an instrument.

The right-click menu for tasks has the most options and allows for:

- Reviewing settings, meta data and the measurement log (“Summary”)
- Plotting of the “Pseudosection”
- Looking at the IP time window plots (“IP Decay Curves”)

- Analysing and exporting full waveform plots (“Full Waveform”)
- Reviewing the contact resistances on each electrode (“Electrode Contact Test”)
- Filtering of bad data (in the “Table” view, right-click on the entries with poor data and select “Filter Datapoint(s)”)
- Locating each station on a map or satellite image (“Show on map”)
- Correct electrode spacing mistakes, correct positions of intentionally offset electrodes, and/or add elevation data (“Edit Electrode Coordinates”)
- Export data to a number of different formats (“Export...”, see Figure 128)

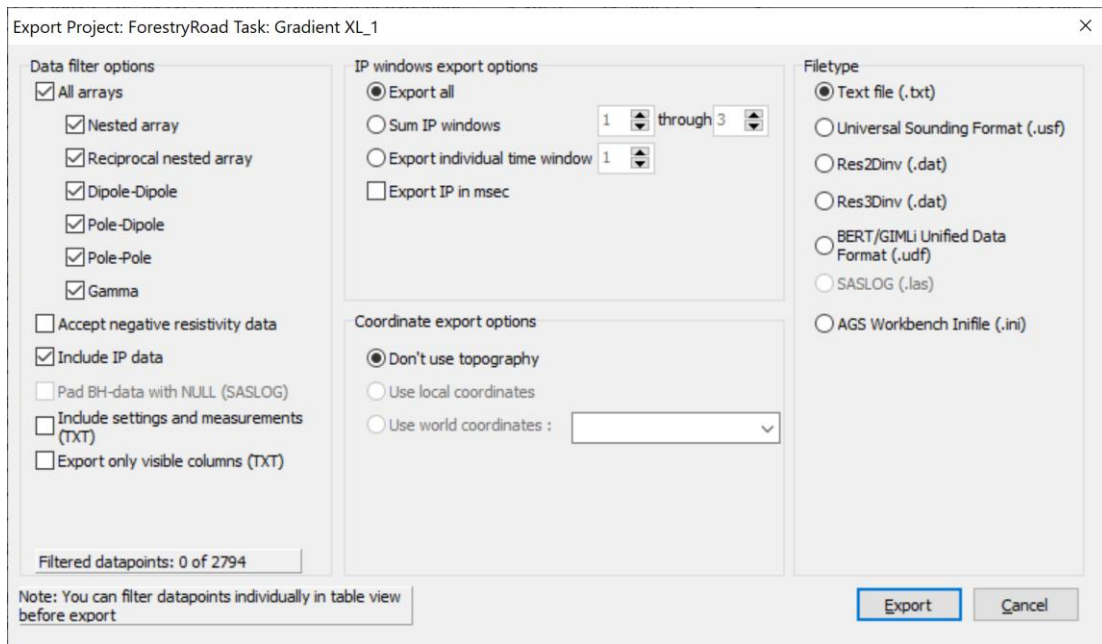

Figure 128 LS Toolbox export window

Export options include generic text files (the whole table or a subset of the available parameters), industry standard formats and proprietary software formats. IP data can be exported such that the original time windows are maintained, or they can be summed to produce a single value for chargeability.

13 APPENDIX E. TECHNICAL SPECIFICATION

13.1 General

Casing	Rugged Aluminium case meets IEC IP 66
Computer	Embedded ARM 9, 400 MHz
GPS	Built-in GPS with support for GLONASS
Display	8,4" Active TFT LCD, full colour, daylight visible
I / O ports	2 x KPT 32-pin for imaging 1 x AUX 1 x Interconnect USB A MicroSD card slot RJ45 for LAN
WLAN	IEEE 802.11 b/g/n, built-in antenna
Measure modes	Resistivity, SP, Resistivity and IP, Resistivity and IP using 100 % duty cycle (dependent on model)
Service point	Accessible through Internet
Memory Capacity	16 GB, microSD card accessible from outside
Power	2x hot swappable, 10.8 V, 6.8 Ah internal Li-ion batteries Built-in charger 12-18 VDC external power
Temperature range	- 20 °C to + 70 °C operating ^{1,2} - 30 °C to + 80 °C storage ³
Dimensions (WxLxH)	39 x 21 x 32 cm
Weight	13.2 kg (12.2 kg without internal battery)

Note 1: Measuring speed may be reduced in high ambient temperature combined with high output power

Note 2: The performance of the LCD is not guaranteed below 0 °C

Note 3: Non-condensing

13.2 Receiver

Number of channels	Up to 12 (+2 for transmitter monitoring) Dependent on model
Isolation	All channels are galvanically separated
Range	± 2.5 V, ± 15 V, ± 600 V Dependent on model
Input Voltage Protection	1000 V
IP windows	Up to 20, user defined
Input Impedance	200 M Ω (± 2.5 V range), 30 M Ω (± 15 V range), 20 M Ω (± 600 V range)
Precision	0.1 %
Accuracy	0.2 %
Resolution	Up to 3 nV at 1 sec integration (theoretical)
Linearity	0.005 %
Flat frequency response	Better than 1 % up to 300 Hz
Full waveform recording	All Rx channels, plus Tx output voltage / current, up to 9000 Hz sampling Dependent on model

13.3 Transmitter

Maximum output power	Up to 250 W Dependent on model
Current transmission	Constant current transmitter
Maximum output current	2500 mA Dependent on model
Maximum output voltage	+ / - 600 V (1200 V peak to peak) Dependent on model
Current accuracy	0.2 %
Current precision	0.1 %
Instant polarity changer	Yes
Self-diagnostics	Monitoring of temperature and power dissipation
Safety	Easily accessible safety switch
Full waveform recording	Built-in monitoring of current and voltage output, up to 9000 Hz sampling Dependent on model

13.4 Multi-Electrode Survey Systems for 2D & 3D

Number of electrodes	Up to 81, using internal electrode selector Up to 16384, using external electrode selectors
Internal Switching matrix	10x64, divided into four blocks for effective use of all receiver channels available
Roll-along	Full coverage, both 2D and 3D
Pre-installed array types	Multiple Gradient Dipole-Dipole Wenner Schlumberger (Wenner-Schlumberger) Pole-Dipole and Pole-Pole
Remote electrodes	2 remote electrodes in addition to in-line electrodes
Diagnostics	Electrode contact resistance, isolation and continuity tests, self-test of transmitter and receiver circuits, relay test

13.5 Software & Communication

The Terrameter LS 2 is controlled using the incorporated firmware. It supports multi-electrode survey systems in 1D, 2D & 3D for Resistivity, IP, and SP measurement, imaging & monitoring.

It has a graphical user interface that is easy to follow in all aspects. Clear and intuitive menus are accompanied by instructive text, graphics and tips, through the ABEM Active Guidance feature. This will assist the user in the operation of the instrument and guide them to collecting good quality data, time after time.

For enhanced data quality control in the field, it is possible to display the measured resistivity and imaging data in real time, tabulated for ease of analysis, plus the ability to view a pseudosection of the data values. Instrument access via USB, Wi-Fi and RJ-45 (for LAN), ensures transfer of data to other computers is extremely simple.

For inversion of data external software is required. Examples of suitable processing software are Aarhus Workbench (with the ERT/IP module), Res2Dinv and Res3Dinv to name just a selection.



GUIDELINE**GEO** | **ABEM** | **MALÅ**